



Ace Roto-Mold

A DIVISION OF DEN HARTOG INDUSTRIES, INC.



STORAGE & CONTAINMENT



Den Hartog

INDUSTRIES, INC.

Den Hartog Industries; "Always At Your Service" providing innovative industry-leading product and service solutions with integrity. Den Hartog Industries is committed to providing quality products and being "Always At Your Service". We will involve everyone in the organization to continually improve our products and processes to ensure total customer satisfaction.

Den Hartog Industries, Inc. features four manufacturing divisions.

Ace Roto-Mold

Ace Roto-Mold tanks and marine products are well known for high quality rotationally-molded tanks and accessories, as well as custom made products.

Injection Molding

The Injection Division has the ability to take your project from conception to reality with complete, in-house services such as injection molding, packaging, printing and assembly.

Blow Molding

The Blow Molding Division can efficiently produce high quality products at a low part cost.

Metal Fabrication

A wide range of capabilities allows this division to produce various custom projects. Known for the Sowjoy line of hog confinement systems, this division also provides metal products to the Ace Roto-Mold line.

Powder Coating

Ace Roto-Mold's metal accessories and custom metal fabrication projects feature a durable and protective powder coated finish. With facilities on-site, powder coating is also offered as a separate secondary service.

TRANSPORTATION

Manufacturing high quality tanks for industrial and agricultural needs is just part of the job.

Den Hartog Industries delivers—literally. Our company-owned and operated fleet will deliver your order promptly and conveniently to your business or work site. Our custom fleet of trucks and trailers reduces transportation costs while increasing responsiveness and convenience to our customers. The Den Hartog transportation service is one more way we live up to our motto, "Always At Your Service."

APPLICATION GUIDELINES

A booklet containing additional information on tank selection and application, chemical resistance, materials information, tank drawings, handling, installation and use guidelines, fitting installation guidelines, and general customer information is available upon request.

Application guidelines are also available online at www.denhartogindustries.com/appguide.asp.

CHEMICAL COMPATIBILITY

Always verify your chemical compatibility with tanks, fittings, and gaskets. Consult your chemical manufacturer regarding applications.

*Cover photos courtesy of Simpson Farm Enterprises, Inc.
& J.D. Skiles Company, Inc.





Ace Roto-Mold

A DIVISION OF DEN HARTOG INDUSTRIES, INC.

TABLE OF CONTENTS

VERTICAL TANKS	4-5
FREE STANDING HORIZONTAL LEG TANKS/HOOPS, SKIDS & BANDS	6-8
ELLIPTICAL TANKS & CRADLES	9
CONE BOTTOM TANKS & STANDS	10
INDUCTOR TANKS & STANDS	11
SPOT SPRAYER APPLICATOR TANKS	12
OPEN TOP CONTAINMENT TANKS	13
PICKUP TANKS/STOCK TANKS	14
HORIZONTAL TANKS & CRADLES	15
ACE H2O WATER ONLY VERTICAL TANKS/GUSSETED VERTICAL TANKS/TANK STANDS	16
STACKABLE TOTES/PALLET PAKS	17
SPECIALTY TANKS: RINSE TANKS/RECTANGLE FLAT BOTTOM TANKS/APPLICATOR TANKS	18
UTILITY TANKS/LOW PROFILE TANKS/RECTANGLE TOTAL DRAIN TANKS	19
PCO TANKS & BANDS	20
LIQUID FEEDER TANKS/MISCELLANEOUS/FUEL TANKS	21
TRACTOR MOUNTED TANKS	22
CROP CARE TANKS & HOOPS	23
ACCESSORY PARTS: FITTINGS/ACCESSORY CLIPS/LIDS/SPINWELDS	24-25
SEPTIC TANKS/CISTERN TANKS/ACCESSORIES	26

Den Hartog Industries, Inc. • 4010 Hospers Drive South • PO Box 425 • Hospers, IA 51238-0425
Customer Service/Sales Support: email: sales@denhartogindustries.com • www.denhartogindustries.com
(712) 752-8432 • (800) 342-3408 • Fax (712) 752-8222



VERTICAL BULK STORAGE TANKS

Vertical Tanks are free standing with a flat bottom for indoor or outdoor installations. Tanks are manufactured from medium- or high-density polyethylene with U.V. inhibitors. Tank walls are translucent for level viewing and equipped with gallon indicators. Specific gravity is listed below.



4

PART NO.	CAPACITY	SPECIFIC GRAVITY	WEIGHT	DIMENSIONS (diameter x height)	LID	FITTING
VT0020-16†	20 Gallon	2.0	13	16 x 28	8"	3/4"
VT0025-18†	25 Gallon	2.0	12	18 x 30	5"	3/4"
VT0040-18†	40 Gallon	2.0	17	18 x 43	5"	3/4"
VT0055-20†	55 Gallon	2.0	22	20 x 47	5"	1"
VT0065-23†	65 Gallon	2.0	25	23 x 42	5"	1"
VT0075-23†	75 Gallon	2.0	28	23 x 50	7"	1"
VT0100-28†	100 Gallon	2.0	36	28 x 45	7"	1"
VT0105-23†	105 Gallon	2.0	38	23 x 65	7"	1"
VT0110-32	110 Gallon	2.0	40	32 x 41	5"	2" Top
VT0130-32	130 Gallon	2.0	47	32 x 46	8"	1"
VT0135-28	135 Gallon	2.0	45	28 x 59	8"	1"
VT0160-28	160 Gallon	2.0	56	28 x 68	8"	1"
VT0175-31	175 Gallon	2.0	54	31 x 61	8"	1-1/2"
VT0180-40	180 Gallon	2.0	48	40 x 45	5"	2" Top
VT0210-40	210 Gallon	2.0	56	40 x 49	5"	2" Top (molded in)
VT0225-31	225 Gallon	2.0	65	31 x 76	8"	1-1/2"
VT0265-31	265 Gallon	2.0	74	31 x 88	8"	1-1/2"
VT0295-42	295 Gallon	2.0	74	42 x 55	16"	2"
VT0300-35	300 Gallon	2.0	86	35 x 81	8"	2"
VT0300-42	300 Gallon	2.0	72	42 x 55	8"	2"
VT0405-52	405 Gallon	2.0	90	52 x 48	8"	2"
VT0420-42	420 Gallon	2.0	102	42 x 75	16"	2"
VT0425-42	425 Gallon	2.0	100	42 x 75	8"	2"
VT0500-46	500 Gallon	2.0	118	46 x 77	8"	2"
VT0505-46	505 Gallon	2.0	118	46 x 80	16"	2"
VT0550-52	550 Gallon	2.0	116	52 x 66	8"	2"
VT0600-46	600 Gallon	2.0	130	46 x 91	16"	2"
VT0625-64	625 Gallon	2.0	100	64 x 50	8"	2"

† indicates can be shipped via UPS/FedEx Syphon tube included with tanks 300 gallons or greater.



Tie-down feature on large verticals.



PART NO.	CAPACITY	SPECIFIC GRAVITY	WEIGHT	DIMENSIONS (diameter x height)	LID	FITTING
VT0800-46	800 Gallon	1.7	175	46 x 118	16"	2"
VT0850-54	850 Gallon	1.7	182	54 x 94	8"	2"
VT0900-46	900 Gallon	1.7	220	46 x 132	16"	2"
VT1000-64	1000 Gallon	1.7	250	64 x 81	16"	2"
VT1050-86	1050 Gallon	1.7	190	86 x 54	16"	2"
VT1200-64	1200 Gallon	1.7	275	64 x 97	16"	2"
VT1350-86	1350 Gallon	1.7	228	86 x 65	16"	2"
VT1500-64	1500 Gallon	1.7	335	64 x 115	16"	2"
VT1500-86	1500 Gallon	1.7	250	86 x 69	16"	2"
VT1525-64	1525 Gallon	1.7	350	64 x 122	16"	2"
VT1650-86	1650 Gallon	1.7	276	86 x 74	16"	2"
VT2000-64	2000 Gallon	1.7	465	64 x 156	16"	2"
VT2000-90	2000 Gallon	1.7	375	90 x 84	16"	2"
VT2050-86	2050 Gallon	1.7	402	86 x 93	16"	2"
VT2150-102	2150 Gallon	1.7	417	102 x 71	16"	2"
VT2500-90	2500 Gallon	1.7	420	90 x 103	16"	2"
VT3000-90	3000 Gallon	1.7	550	90 x 120	16"	2"
VT3100-102*	3100 Gallon	1.7	550	102 x 103	16"	2"
VT3400-102*	3400 Gallon	1.7	585	102 x 107	16"	2"
VT4000-96*	4000 Gallon	1.7	900	96 x 140	16"	2"
VT4200-96*	4200 Gallon	1.7	950	96 x 148	16"	2"
VT5000-102**	5000 Gallon	1.7	1302	102 x 156	16"	2"
VT5150-102**	5150 Gallon	1.7	1350	102 x 161	16"	2"
VT6250-102**	6250 Gallon	1.7	1550	102 x 194	16"	2"
VT6500-120**	6500 Gallon	1.7	1502	120 x 152	16"	2"
VT7000-142**	7000 Gallon	1.7	1750	142 x 125	16"	2"
VT7800-120**	7800 Gallon	1.7	1900	120 x 176	16"	2"
VT8000-120**	8000 Gallon	1.7	1930	120 x 180	16"	2"
VT9150-120**	9150 Gallon	1.7	2200	120 x 203	16"	2"
VT10500-2500**	10,500 Gallon	1.6	2500	142 x 177	16"	2"
VT10500-2800**	10,500 Gallon	1.8	2800	142 x 177	16"	2"

*indicates heavy duty fitting
Siphon tube included with tanks 300 gallons or greater.

**indicates available with 3" fitting



FREE-STANDING HORIZONTAL BULK STORAGE TANKS

Free Standing Tanks are selected when transportable (non DOT approved) containment is required for indoor or outdoor applications. Tanks are equipped with molded-in legs to support the tank and band locators for tie down. Tanks are manufactured from medium- or high-density polyethylene with U.V. inhibitors and designed for containment of liquids of up to 1.7 specific gravity. Tank walls are translucent for level viewing and equipped with gallon indicators.

PART NO.	CAPACITY		WEIGHT	DIMENSIONS	LID	FITTING
FM0015-14S [†]	15 Gallon		11	14 x 30	5"	
FM0025-16S [†]	25 Gallon		15	16 x 34	5"	
FS0035-18 [†]	35 Gallon		16	18 x 34	5"	1"
FS0065-24 [†]	65 Gallon		32	24 x 39	5"	1"
FS0070-24 [†]	70 Gallon	stackable (3 high)	35	24 x 39	5"	1"
FS0125-32	125 Gallon		52	32 x 40	8"	1"
FS0165-32	165 Gallon		70	32 x 54	8"	1"
FS0225-38	225 Gallon		85	38 x 52	8"	2"
FS0325-38	325 Gallon		106	38 x 72	12"	2"
FS0335-44	335 Gallon		116	44 x 56	16"	2"
FS0510-57	510 Gallon	Elliptical	162	57 x 80 x 39	16"	2"
FS0535-48	535 Gallon		160	48 x 78	16"	2"
FS0735-48	735 Gal (Hoops Req.)		250	48 x 103	16"	2"
FM0925-DS	925 Gal (Hoops Req.)		290	62 x 81	16"	2"
FS0925-DW	925 Gal (Hoops Req.)		290	62 x 81	16"	2"
FS1005-48	1005 Gal (Hoops Req.)		340	48 x 130	16"	2"
FS1010-48*	1010 Gal (Hoops Req.)		340	48 x 130	16"	2"
FS1035-78	1035 Gal (Hoops Req.)	Elliptical	290	78 x 90 x 52	16"	2"
FM1065-56S	1065 Gal (Hoops Req.)		340	56 x 105	16"	2"
FS1065-56W	1065 Gal (Hoops Req.)		340	56 x 105	16"	2"
FM1300-DS	1300 Gal (Hoops Req.)		425	62 x 114	16"	2"
FS1300-DW	1300 Gal (Hoops Req.)		425	62 x 114	16"	2"
FS1610-78*	1610 Gal (Hoops Req.)	Elliptical	530	78 x 139 x 58	16"	2"
FM1750-62S	1750 Gal (Hoops Req.)		616	62 x 147	16"	2"
FS1750-62W	1750 Gal (Hoops Req.)		616	62 x 147	16"	2"
FM1800-2S	1800 Gal (Hoops Req.)	multi tanks (2)	580	62 x 149	16"	2"
FS1800-2W	1800 Gal (Hoops Req.)	multi tanks (2)	580	62 x 149	16"	2"
FS2350-88	2350 Gal (Hoops Req.)	Elliptical	920	88 x 146 x 63	16"	2"
FM2600-2S	2600 Gal (Hoops Req.)	multi tanks (2)	850	62 x 212	16"	2"
FS2600-2W	2600 Gal (Hoops Req.)	multi tanks (2)	850	62 x 212	16"	2"
FS2750-88	2750 Gal (Hoops Req.)	Elliptical	1150	88 x 146 x 70	16"	2"
FS3200-2S*	3200 Gal (Hoops Req.)	multi tanks (2) / Elliptical	1100	88 x 172 x 74	16"	2"
FS3250-88	3250 Gal (Hoops Req.)	Elliptical	1208	88 x 146 x 79	16"	2"

FMxxxx-S= Sump FSxxx-W = Without Sump [†]indicates can be shipped via UPS/FedEx D=Domed End *skid required to support elevated legs
 When ordering, please indicate whether the fitting should be installed, not installed, or shipped loose. If installed, indicate preferred fitting location (END or SIDE are most common). Tanks must be fully supported for transport.

"Donut" stabilizes sectional tanks.

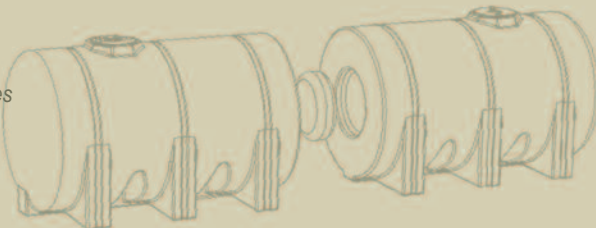

FS3200-2S



FS2750-88



FS3250-88



FS0510-57



FS1010-48

HOOPS, BAFFLES AND SKIDS

PART NO.	CAPACITY	WEIGHT	DIMENSIONS
FS048-HP	735 Gal Hoops	Set of 3	1.315 OD
FS062-HP-925	925 Gal Hoops	Set of 2	1.66 OD
FS062-HP-1300	1300 Gal Hoops	Set of 3	1.66 OD
FS062-HP-1750	1750 Gal Hoops	Set of 4	1.66 OD
FS062-HP-1800C	1800 Gal Hoops	Set of 4	1.66 OD
FS062-HP-2600C	2600 Gal Hoops	Set of 6	1.66 OD
FS0510-HP	510 Gal Hoops	Set of 3	1.315 OD
FS1005-HP	1005 Gal Hoops	Set of 4	1.315 OD
FS1010-HP	1010 Gal Hoops	Set of 4	1.315 OD
FS1035-HP	1035 Gal Hoops	Set of 3	1.66 OD
FS1065-HP	1065 Gal Hoops	Set of 3	1.315 OD
FS1065-BAF	1065 Gal Baffles	38	
FS1610-HP	1610 Gal Hoops	Set of 4	1.66 OD
FS2350-HP	2350 Gal Hoops	Set of 4	1.90 OD
FS2750-HP	2750 Gal Hoops	Set of 4	1.90 OD
FS3200-HP	3200 Gal Hoops	Set of 4	1.66 OD
FS3250-HP	3250 Gal Hoops	Set of 4	1.90 OD
FS3250-LAD	3250 Ladder	46	16 x 78
FS0925-SK	925 Gal Skid	280	61 x 64
FS1010-SK	1010 Gal Skid	409	53 x 115
FM1065-SKS	1065 Gal Skid w/sump	280	61 x 78
FS1065-SKW	1065 Gal Skid w/o sump	200	59 x 100
FS1300-SK	1300 Gal Skid	450	64 x 104
FS1610-SK	1610 Gal Skid	490	83 x 112
FS1750-SK	1750 Gal Skid	604	64 x 138
FM1800-SKS	1800 Gal Skid w/sump	580	64 x 125
FS1800-SKW	1800 Gal Skid w/o sump	382	64 x 125
FS2350/3250-SK	2350/2750/3250 Gal Skid	1078	88 x 146
FS2600-SK	2600 Gal Skid	900	64 x 201
FS3200-SK	3200 Gal Skid	1163	90 x 168



FS2350-88



FS1750-62W

FREE-STANDING HORIZONTAL LEG TANK/HOOPS, SKIDS & BANDS (CON'T)

POWDER COATED STEEL BANDS WITH J-BOLT

Heavy gauge steel bands available for 35 through 535-gallon tanks. Silver powder coated finish on all bands except 35 and 65-gallon tanks which are stainless steel. Bands feature reinforced holes for J-Bolts which allow additional mounting hole flexibility.

PART NO.	CAPACITY	WEIGHT	BANDS
FS0035-SB*†	35 Gallon Kit Silver	18 ga.	2 x 45
FS0065-SB*†	65 Gallon Kit Silver	18 ga.	2 x 61
FS125/165-SBPJ†	125/165 Gallon Kit Silver	14 ga.	3 x 80
FS225/325-SBPJ†	225/325 Gallon Kit Silver	14 ga.	3 x 95
FS0335-SBPJ†	335 Gallon Kit Silver	14 ga.	3 x 110
FS0535-SBPJ†	535 Gallon Kit Silver	14 ga.	3 x 120

*Stainless Steel Bands



Bands with J-Bolt

POWDER COATED STEEL BANDS WITH FORMED FEET

Heavy gauge steel bands available for 35 through 535-gallon tanks. Silver powder coated finish on all bands. Bands feature a formed foot for securely fastening tank to platform surface. Formed foot provides a more rigid connection for tank.

PART NO.	CAPACITY	WEIGHT	BANDS
FS0035-SBPF†	35 Gallon Kit Silver	8	2 x 47.5
FS0065-SBPF†	65 Gallon Kit Silver	12	2 x 67
FS125/165-SBPF†	125/165 Gallon Kit Silver	16	2.5 x 84.5
FS225/325-SBPF†	225/325 Gallon Kit Silver	19	2.5 x 99.5
FS0335-SBPF†	335 Gallon Kit Silver	34	2.75 x 116.5
FS0535-SBPF†	535 Gallon Kit Silver	36	2.75 x 125



Bands with Feet

BAFFLES

Ace Roto-Mold has developed a unique baffle system that is easy to install and clean. These baffles help to reduce fluid sloshing. Baffle systems come standard in some tanks and offered as an option in others.

OPTIONAL	STANDARD
FM1065-56S	FS1610-78
FS1065-56W	FM1750-62S
	FS1750-62W
	FS2350-88
	FS2750-88
	FS3250-88

†indicates can be shipped via UPS/FedEx

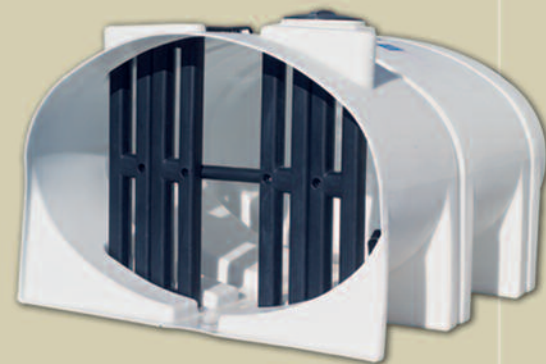

Poly baffles for fluid control



Baffles are inserted through the lid and are installed prior to shipment.

ELLIPTICAL TANKS

Elliptical Tanks can be selected for stationary or transportable (non DOT approved) applications both indoors and outdoors. The elliptical tank lowers the center of gravity to enhance stability and visibility. The tanks feature a standard 2-1/2" collection sump on the bottom for full drain out. An 8-1/2" deep sump option is available on five sizes. Sump is located directly under the lid on standard tanks, but a center sump option is available on tanks from 500-1250 gallons. These tanks require the bottom to be fully supported with a cradle for use. The tanks are manufactured from medium-density polyethylene with U.V. stabilizers and are designed for containment of liquids of up to 1.7 specific gravity. Tank walls are translucent for level viewing and equipped with gallon indicators.

PART NO.	CAPACITY	WEIGHT	DIMENSIONS (width x length x height)	LID	FITTING
HE0200-41	200 Gallon	82	41 x 66 x 26	8"	3/4" & 1-1/4"
HE0300-48	300 Gallon	112	48 x 70 x 30	8"	3/4" & 1-1/4"
HE0400-57	400 Gallon	127	57 x 70 x 36	8"	3/4" & 1-1/4"
HE0500-57	500 Gallon	163	57 x 82 x 36	8"	3/4" & 1-1/4"
HED0500-57	500 Gallon Deep (8.5") Sump	163	57 x 82 x 36	8"	3/4" & 1-1/4"
HE0750-69	750 Gallon	220	69 x 89 x 42	16"	1-1/4" & 2"
HED0750-69	750 Gallon Deep (8.5") Sump	220	69 x 89 x 42	16"	1-1/4" & 2"
HE0850-69	850 Gallon	246	69 x 89 x 46	16"	1-1/4" & 2"
HED0850-69	850 Gallon Deep (8.5") Sump	246	69 x 89 x 46	16"	1-1/4" & 2"
HE1000-78	1000 Gallon	285	78 x 90 x 49	16"	1-1/4" & 2"
HED1000-78	1000 Gallon Deep (8.5") Sump	285	78 x 90 x 49	16"	1-1/4" & 2"
HE1250-78	1250 Gallon	400	78 x 92 x 60	16"	1-1/4" & 2"
HED1250-78	1250 Gallon Deep (8.5") Sump	400	78 x 92 x 60	16"	1-1/4" & 2"
HE1600-78	1600 Gallon	439	78 x 138 x 49	16"	2"
HED1600-78	1600 Gallon Deep (6") Sump	439	78 x 138 x 49	16"	2"

CRADLES FOR ELLIPTICAL TANKS

PART NO.	CAPACITY	WEIGHT	BANDS
HE0200-C	200 Gallon	140	3" x 61"
HE0300-C	300 Gallon	155	3" x 74"
HE0400-C	400 Gallon	190	4" x 88"
HE0500-C	500 Gallon	202	4" x 88"
HE0750-C	750 Gallon	451	4" x 91"
HE0850-C	850 Gallon	453	4" x 99"
HE1000-C	1000 Gallon	515	4" x 105"
HE1250-C	1250 Gallon	520	4" x 126"
HE1600-C	1600 Gallon	578	3.5" x 124"

Drain Options
Available on 500-1250 gallon tanks

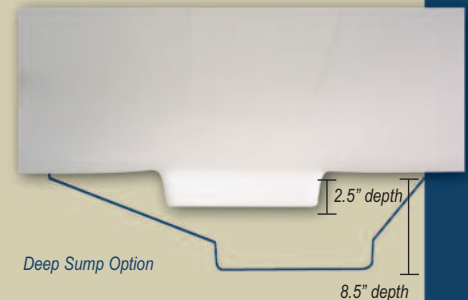

CB2600-86

CONE BOTTOM BULK STORAGE TANKS

CB1000-64
w/CB064-45ST

Cone Bottom Tanks are selected when a more complete drain out of stored chemical is required in indoor or outdoor installations. Tanks require stands to support the conical bottoms. Tanks are manufactured from medium- or high-density polyethylene with U.V. inhibitors and designed for containment of liquids of up to 1.7 specific gravity. Tank walls are translucent for level viewing and equipped with gallon indicators.

CB1700-86 w/CB086-15ST

CB0200-42
w/CB042-45ST

10

PART NO.	CAPACITY	SPECIFIC GRAVITY	WEIGHT	TANK DIMENSIONS (diameter x height)	OVERALL HEIGHT (including stand)	LID	FITTING
CB0150-36	150 Gallon-45 deg	2.0	61	36 x 51	63"	12"	2"
CB0200-42	200 Gallon-45 deg	2.0	75	42 x 55	65"	12"	2"
CB0300-42	300 Gallon-45 deg	2.0	100	42 x 67	76"	16"	2"
CB0345-52	345 Gallon-45 deg	2.0	100	52 x 58	70"	12"	2"
CB0350-42	350 Gallon-45 deg	2.0	118	42 x 81	93"	12"	2"
CB0500-52	500 Gallon-45 deg	2.0	130	52 x 81	92"	12"	2"
CB1000-64	1000 Gallon-45 deg	1.7	250	64 x 98	112"	16"	2"
CB1000-90	1000 Gallon-15 deg	1.7	210	90 x 54	64"	16"	2"
CB1200-90	1200 Gallon-15 deg	1.7	240	90 x 62	74"	16"	2"
CB1300-90	1300 Gallon-15 deg	1.7	260	90 x 65	75"	16"	2"
CB1490-64	1490 Gallon-45 deg	1.7	340	64 x 132	146"	16"	2"
CB1600-90	1600 Gallon-30 deg	1.7	284	90 x 85	93"	16"	2"
CB1700-86	1700 Gallon-15 deg	1.7	284	86 x 85	96"	16"	2"
CB2500-90	2500 Gallon-15 deg	1.7	435	90 x 111	121"	16"	2"
CB2600-90	2600 Gallon-30 deg	1.7	500	90 x 123	129"	16"	2"
CB2600-86	2600 Gallon-45 deg	1.7	500	86 x 146	154"	16"	2"
CB3000-90	3000 Gallon-15 deg	1.7	550	90 x 128	137"	16"	2"
CB4600-102*	4600 Gallon-15 deg	1.7	1200	102 x 155	166"	16"	2"
CB4900-102*	4900 Gallon-15 deg	1.7	1300	102 x 159	170"	16"	2"
CB6900-122**	6900 Gallon-15 deg	1.7	1700	122 x 168	177"	16"	2"
CB8250-122**	8250 Gallon-15 deg	1.7	2100	122 x 195	205"	16"	2"

* indicates heavy duty fitting * indicates available with 3" fitting

CONE BOTTOM STANDS

PART NO.	CAPACITY	WEIGHT	CLEARANCE (from tank to ground)
CB036-45ST	150 Gal-45 deg	63	12"
CB042-45ST	200, 300 or 350 Gal-45 deg	82	11"
CB052-45ST	345 or 500 Gal-45 deg	174	13"
CB064-45ST	1000 or 1490 Gal-45 deg	320	14"
CB086-15ST	1700 Gal-15 deg	360	11"
CB086-45ST	2600 Gal-45 deg	580	12"
CB090-15ST	1000, 1200, 1300, 2500 or 3000 Gal-15 deg	380	11"
CB090-30ST	1600 or 2600 Gal-30 deg	640	9"
CB102-15ST	4600 or 4900 Gal-15 deg	448	11"
CB122-15ST	6900 or 8250 Gal-15 deg	1020	10"

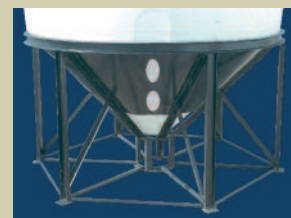
CB086-45ST
Fluid View
Feature

INDUCTOR BULK STORAGE TANKS

Inductor Tanks are selected as supply tanks for indoor or outdoor applications and feature conical bottoms to facilitate liquid drain out. Tanks feature a bulkhead fitting for supply line connection. New "Full-Drain" tanks are available with molded in threaded outlet for complete drainage. Tanks require stands to support the conical bottoms. Tanks are manufactured from medium-density polyethylene with U.V. inhibitors and designed for containment of liquids of up to 1.7 specific gravity. Tank walls are translucent for level viewing and equipped with gallon indicators.

PART NO.	CAPACITY	WEIGHT	DIMENSIONS (diameter x height)	LID	FITTING
IN0015-19 [†]	15 Gallon	10	19 x 24	12"	2" FPT
INFD15-19 [†]	15 Gallon Full Drain	10	19 x 27	12"	1 1/2" FPT BOSS
IN0015-19SM [†]	15 Gallon Side Mount	8	19 x 24	12"	2" FPT
IN0030-24 [†]	30 Gallon	15	24 x 30	12"	2" FPT
INFD30-24 [†]	30 Gallon Full Drain	15	24 x 33	12"	1 1/2" FPT BOSS
IN0040-30 [†]	40 Gallon Full Drain	26	30 x 34	12"	2" MPT BOSS
IN0060-24 [†]	60 Gallon x 24	22	24 x 42	12"	2" FPT
INFD60-24 [†]	60 Gallon x 24 Full Drain	22	24 x 46	12"	1 1/2" FPT BOSS
INFD60-30 [†]	60 Gallon x 30 Full Drain	26	30 x 38	16"	2" MPT BOSS
IN0085-30	85 Gallon	35	30 x 43	12"	2" FPT
IN0110-30	110 Gallon	42	30 x 51	12"	2" FPT

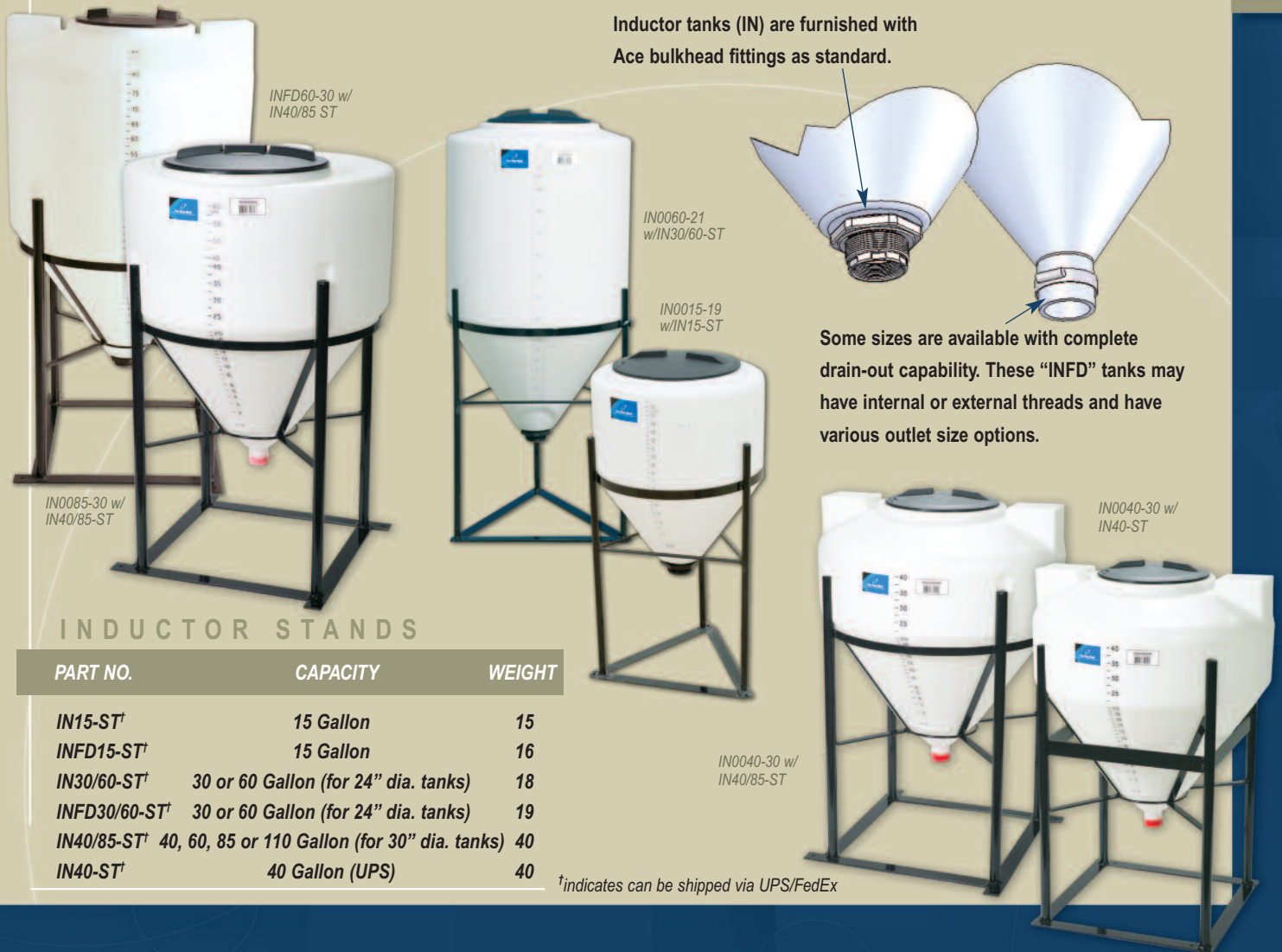

Inductor tanks (IN) are furnished with Ace bulkhead fittings as standard.

Some sizes are available with complete drain-out capability. These "INFD" tanks may have internal or external threads and have various outlet size options.

INDUCTOR STANDS

PART NO.	CAPACITY	WEIGHT
IN15-ST [†]	15 Gallon	15
INFD15-ST [†]	15 Gallon	16
IN30/60-ST [†]	30 or 60 Gallon (for 24" dia. tanks)	18
INFD30/60-ST [†]	30 or 60 Gallon (for 24" dia. tanks)	19
IN40/85-ST [†]	40, 60, 85 or 110 Gallon (for 30" dia. tanks)	40
IN40-ST [†]	40 Gallon (UPS)	40

[†]indicates can be shipped via UPS/FedEx

SPOT SPRAYER APPLICATOR TANKS

Spot Sprayer Tanks are designed as portable applicator supply tanks and are equipped with pump and equipment mount inserts. Tanks are equipped with molded in legs to support the tank and band locators for tie down. Tanks mount with bottom inserts. Tanks are manufactured from linear low-density polyethylene with U.V. inhibitors and designed for containment of liquids of up to 1.7 specific gravity. Tank walls are translucent for level viewing and equipped with gallon indicators.

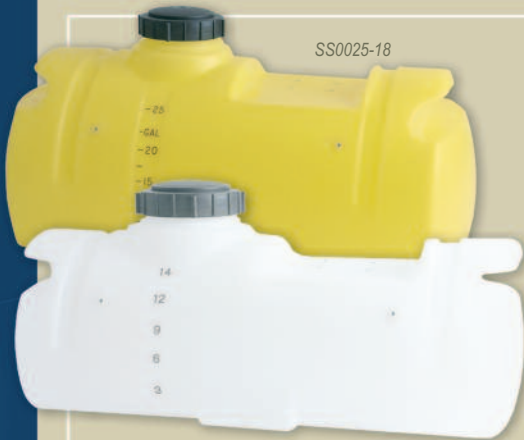

SS0025-18

SS0014-14



SB00060

SB00060



SB00040 Pallet



SB00040

PART NO.	CAPACITY	WEIGHT	DIMENSIONS (width x length x height)	LID	
SM0014-14S [†]	14 Gallon	with sump	8	14 x 30 x 14	5"
SS0014-14 [†]	14 Gallon	without sump	8	14 x 30 x 14	5"
SM0025-18S [†]	25 Gallon	with sump	14	18 x 34 x 18	5"
SS0025-18 [†]	25 Gallon	without sump	14	18 x 34 x 18	5"

[†]indicates can be shipped via UPS/FedEx

BLOW MOLDED APPLICATOR TANKS

Blow Molded Applicator Tanks are designed with injection-molded leg inserts that allow the tanks to be anchored for transportable applications. They are furnished with brass inserts for pump and wand clip mounting. Tanks are manufactured from high-density polyethylene with U.V. stabilizers and designed for containment of liquids up to 1.7 specific gravity. Tanks are equipped with U.S. gallon and metric indicators for liquid level viewing. These tanks are available in white or yellow.

PART NO.	CAPACITY	WEIGHT	DIMENSIONS (width x length x height)	LID
SB00040	40 Gallon	18	24 x 36 x 19	5"
SB00060	60 Gallon	21	24 x 36 x 26	5"

* Blow Molded Applicator Tanks are also offered in pallet quantities. The 40 gallon tanks are available 10 to a pallet and the 60 gallon tanks are 8 to a pallet.

OPEN TOP CONTAINMENT TANKS

Open Top Tanks are selected for collection systems, temporary liquid storage or as secondary containment for vertical tanks in indoor or outdoor stationary installations. Tanks are manufactured from medium- or high-density polyethylene with U.V. inhibitors. Tank walls are translucent for level viewing and equipped with gallon indicators. Specific gravity is listed below.



PART NO.	CAPACITY		SPECIFIC GRAVITY	WEIGHT	DIMENSIONS (diameter x height)
OP0210-40	210 Gallon		2.0	52	40 x 42
OP0325-RT	325 Gallon	Rectangle	1.7	115	60 x 96 x 24
OP0360-48	360 Gallon		2.0	115	48 x 48
OP0500-56	500 Gallon	with bolt-on top	2.0	150	56 x 62
OP0625-RT	625 Gallon	Rectangle	1.7	145	72 x 108 x 24
OP0825-RT	825 Gallon	Rectangle	1.7	276	73 x 73 x 66
OP0900-86	900 Gallon		1.7	175	86 x 43
OP1000-74	1000 Gallon	with bolt-on top	1.7	277	74 x 64
OP1200-86	1200 Gallon		1.7	200	86 x 54
OP1325-RT	1325 Gallon	Rectangle	1.7	360	84 x 84 x 60
OP1350-86	1350 Gallon		1.7	217	86 x 62
OP1500-86	1500 Gallon		1.7	240	86 x 68
OP1700-90	1700 Gallon		1.7	317	90 x 66
OP1825-RT	1825 Gallon	Rectangle	1.7	520	96 x 96 x 62
OP2200-90	2200 Gallon		1.7	365	90 x 85
OP2700-90	2700 Gallon		1.7	480	90 x 103
OP3300-102	3300 Gallon		1.7	550	102 x 105
OP3700-96	3700 Gallon	optional bolt-on top	1.7	625	96 x 128
OP6800-120	6800 Gallon	optional bolt-on top	1.7	1525	120 x 146

PICKUP TANKS

Pickup Tanks are selected as applicator tanks or when transportable (non DOT approved) containment is required. Tanks are designed to fit most pickup trucks. Tanks are manufactured from medium-density polyethylene with U.V. inhibitors and designed for containment of liquids of up to 1.7 specific gravity. Tank walls are translucent for level viewing and equipped with gallon indicators.



PART NO.	CAPACITY	WEIGHT	DIMENSIONS (diameter x height)	LID	FITTING
PU0200-52	200 Gallon	54	52 x 30	8"	2"
PU0205-52	205 Gallon	87	52 x 52 x 26	7"	2"
PU0305-60	305 Gallon	97	60 x 58 x 30	7"	2"
PU0350-62	350 Gallon	92	62 x 34	8"	2"
PU0450-62	450 Gallon	102	62 x 41	8"	2"

Syphon tube included with all Pickup Tanks.



STOCK TANKS

Stock Tanks are designed for portable livestock watering. Tank tops, sides and bottom are ribbed for strength. Drain plug is provided on all tanks except the 124 model. Tank models are nestable for shipping and storage. Tanks are manufactured from U.S.D.A. compliant low-density polyethylene with U.V. inhibitors and designed for containment of liquids of up to 1.0 specific gravity.



PART NO.	MODEL NO.	CAPACITY	DRAIN PLUG	WEIGHT	DIMENSIONS (diameter x length x height)
ARM-10115	RE124	50 Gallon Oval	No outlet	15	50 x 31 x 12
ARM-10116	RE224	100 Gallon Oval	1"	25	55 x 31 x 25
ARM-19455	R42	120 Gallon Round	1-1/2"	32	48 x 24
ARM-10117	RE226	150 Gallon Oval	1"	46	75 x 31 x 25
ARM-10138	R62	320 Gallon Round	1-1/2"	62	72 x 24
ARM-10139	R82	610 Gallon Round	1-1/2"	92	96 x 24
ARM-10135	R92	920 Gallon Round	1-1/2"	137	106 x 29

ROUND HORIZONTAL BULK STORAGE TANKS

Round Horizontal Tanks are selected when transportable (non DOT approved) containment is required for indoor or outdoor applications. Tanks require skids and bands to support the round bottom. All tanks are equipped with drain out sumps. Tanks are manufactured from medium-density polyethylene with U.V. inhibitors and designed for containment of liquids of up to 1.7 specific gravity. Tank walls are translucent for level viewing and equipped with gallon indicators.



HZ0500-48

HZ0110-30

HZ0025-23

PART NO.	CAPACITY	WEIGHT	DIMENSIONS (diameter x length)	LID	FITTING
HZ0025-23 [†]	25 Gallon	14	23 x 22	5"	3/4"
HZ0055-23 [†]	55 Gallon	23	23 x 38	5"	3/4"
HZ0075-24 [†]	75 Gallon	31	24 x 47	5"	3/4"
HZ0095-24 [†]	95 Gallon	35	24 x 56	5"	1-1/4"
HZ0110-30	110 Gallon	40	30 x 44	8"	1-1/4"
HZ0150-30	150 Gallon x 30	48	30 x 57	8"	3/4" & 1-1/4"
HZ0150-32	150 Gallon x 32	48	32 x 52	8"	3/4" & 1-1/4"
HZ0200-32	200 Gallon x 32	64	32 x 68	8"	3/4" & 1-1/4"
HZ0200-38	200 Gallon x 38	64	38 x 51	8"	3/4" & 1-1/4"
HZ0300-38	300 Gallon	88	38 x 76	8"	3/4" & 1-1/4"
HZ0500-48	500 Gallon	122	48 x 79	8"	3/4" & 1-1/4"

CRADLES FOR HORIZONTAL TANKS

PART NO.	CAPACITY	WEIGHT	BANDS
HZ0025-C ^{†*}	25 Gallon	20	1.5" x 50"
HZ0055-C ^{†*}	55 Gallon	24	2" x 50.5"
HZ0075-C [†]	75 Gallon	36	2" x 51.5"
HZ0095-C [†]	95 Gallon	38	2" x 51.5"
HZ0110-C [†]	110 Gallon	40	2.75" x 60"
HZ0153-C [†]	150 Gallon x 30	57	2.75" x 55"
HZ0150-C	150 Gallon x 32	56	2.75" x 56"
HZ0232-C	200 Gallon x 32	110	2.75" x 57"
HZ0238-C	200 Gallon x 38	85	2.75" x 65"
HZ0300-C	300 Gallon	145	2.75" x 69.5"
HZ0500-C	500 Gallon	170	2.75" x 86.5"

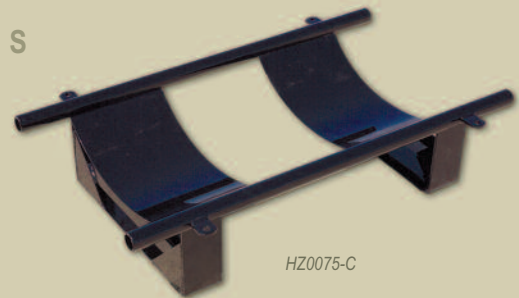

HZ0075-C



HZ0500-C

[†]indicates can be shipped via UPS/FedEx

*Stainless Steel Bands



Ace Roto-Mold ^{H₂O}

ACE H₂O WATER ONLY VERTICAL TANKS

Water Only Vertical Tanks are free standing for indoor or outdoor stationary applications. Tanks are manufactured from FDA compliant high-density polyethylene with U.V. inhibitors. They are designed for the storage of chemicals with a specific gravity of 1.0 or less and available in dark green.

PART NO.	CAPACITY	SPECIFIC GRAVITY	WEIGHT	DIMENSIONS (diameter x height)	LID	FITTING
WO2500-VT	2500 Gallon	1.0	392	96 x 92	16"	2"
WO3000-VT	3000 Gallon	1.0	487	96 x 109	16"	2"



VT28/31-STP

TANK STANDS

PART NO.	CAPACITY	WEIGHT	DIMENSIONS (diameter x height)
VT28/31-STP [†]	31-1/2" Poly	35	39 x 24
VT-ST052	52" Poly	165	52 x 36
VT-ST052FF	52" Foam Filled Poly	201	52 x 36
VT160-28ST	160 Gallon Metal Stand	83	30 x 26
VT265-31ST	265 Gallon Metal Stand	89	33 x 26
VT300-35ST	300 Gallon Metal Stand	114	37 x 38

[†]indicates can be shipped via UPS/FedEx

VT-ST052FF



VT160-28ST



GUSSETED TOP VERTICAL TANKS

Gusseted Top Vertical Tanks are free standing with a flat bottom for indoor or outdoor installations. Tanks are manufactured from medium-density polyethylene with U.V. inhibitors and designed for containment of liquids of up to 1.5 specific gravity. Tank walls are translucent for level viewing and equipped with gallon indicators.

PART NO.	CAPACITY	WEIGHT	DIMENSIONS (diameter x height)	LID	FITTING
GV1050-86	1050 Gallon	175	86 x 50	16"	2"
GV1350-86	1350 Gallon	207	86 x 62	16"	2"
GV1500-86	1500 Gallon	228	86 x 69	16"	2"
GV1650-86	1650 Gallon	255	86 x 74	16"	2"



STACKABLE TOTES

Stackable Totes can be used for indoor or outdoor, stationary or portable applications (non DOT approved). Four lift ears are provided for lifting each tote and a 4-way forklift accessible skid is available for easy handling. Each tote features three 2" threaded ports for dispensing the totes contents. Tanks are manufactured from medium-density polyethylene with U.V. stabilizers. Specific gravity is listed below.

STACKABLE TOTES

PART NO.	CAPACITY	SPECIFIC GRAVITY	WEIGHT	DIMENSIONS (width x length x height)	LID
ST0070-32	70 Gallon	1.5	42	32 x 32 x 25	7"
ST0120-32	120 Gallon	1.5	77	32 x 32 x 38	7"

* ST0070-32 is limited to stacking 3 high * ST0120-32 is limited to stacking 2 high

STACKABLE TOTE ACCESSORIES

PART NO.	DESCRIPTION	CAPACITY	WEIGHT	DIMENSIONS (width x length x height)
ST70-120-SK	Skid	70-120 Gallons	50	30 x 30 x 8
ST70-120-LG	Leg Kit	70-120 Gallons	24	5 x 5 x 26
ST70-120-DT	Drip Tray	70-120 Gallons	15	5 x 20 x 35
ST70-120-PL	Plumbing Kit*	70-120 Gallons		

* Kit options available for multiple tank configurations.

PALLET PAKS

Pallet Pak units are designed for light-duty transport (non DOT approved) for indoor or outdoor applications. The base of the pallet frame is designed for forklift transportability. The rectangular pallet paks have a metal frame and plastic base. The vertical paks have poly bases. The tanks are manufactured from medium-density polyethylene with U.V. inhibitors and are designed for containment of liquids up to 1.7 specific gravity. Tank walls are translucent for level viewing and equipped with gallon indicators.

PART NO.	CAPACITY	WEIGHT	DIMENSIONS	LID	FITTING
SP0150-PP	150 Gal Pallet Pak (1) 150 Gal Tank, Pallet & Frame	201	27 x 43 x 47	7"	2"
SP0150-2TPP	150 Gal Pallet Pak (2) 150 Gal Tanks, Pallet & Frame	356	51 x 43 x 47	7"	2"
SP0300-PP	300 Gal Pallet Pak (1) 300 Gal Tank, Pallet & Frame	316	51 x 43 x 47	7"	2"
VT0110-PP	110 Gal Pallet & Tank	68	33 x 40 x 44	5"	2" TOP
VT0210-PP	210 Gal Pallet & Tank	84	41 x 52	5"	2" TOP

PALLET TANKS ONLY

PART NO.	CAPACITY	WEIGHT	DIMENSIONS	LID	FITTING
SP0150-PPTK*	150 Gal Rectangle	80	24 x 40 x 42	7"	2"
SP0300-PPTK*	300 Gal Rectangle	120	48 x 40 x 42	7"	2"
VT0110-32	110 Gal Tank Only	40	32 x 41	5"	2" TOP
VT0210-40	210 Gal Tank Only	56	40 x 49	5"	2" TOP

* Rectangle tanks used without pallet still require side support



Stackable totes feature a convenient **Lifting Ear** for easy transport!

ST0120-32



ST0070-32



Our totes also feature a **threaded port** for dispensing contents.



ST70-120-PL
& ST70-120-LG

VT0210-PP

VT0110-PP



SP0150-2TPP



SP0150-PP



SPECIALTY BULK STORAGE AND APPLICATOR TANKS

Specialty Tanks are available for a variety of custom applications in both stationary and portable configurations. Tanks are manufactured from medium-density polyethylene with U.V. inhibitors and designed for containment of liquids of up to 1.7 specific gravity. Tank walls are translucent for level viewing and equipped with gallon indicators.

RINSE TANKS

PART NO.	CAPACITY	WEIGHT	DIMENSIONS (width x length x height)	LID	SPINWELD
SP002.5-RT†	2.5 Gal Rectangle	3	7 x 15 x 14	5"	3/4"
SP0003-RT†	3 Gal Rectangle	3	7 x 12 x 14	5"	3/4"
SP003.5-CL†	3.5 Gal Cylinder	4	11 x 15	5"	3/4"
SP0004-SQ5†	4 Gal Square	4	11 x 11 x 15	5"	1-1/4"
SP0004-SQ8†	4 Gal Square	4	11 x 11 x 14	8"	1-1/4"
SP0005-SQ5†	5 Gal Square	6	11 x 11 x 20	5"	1-1/4"
SP0005-SQ8†	5 Gal Square	6	11 x 11 x 18	8"	1-1/4"
SP0010-SQ8†	10 Gal Square	10	13 x 13 x 21	8"	1-1/4"



RECTANGLE TANKS - FLAT BOTTOM

PART NO.	CAPACITY	WEIGHT	DIMENSIONS (width x length x height)	LID	FITTING
SP0005-RT†	5 Gal	5	10 x 22 x 8	5"	
SP0006-2P†	6 Gal w/pump mount & 2" lid	5	12 x 15 x 8	2"	
SP0006-5N†	6 Gal w/5" lid	5	12 x 15 x 8	5"	
SP0007-RT†	7 Gal	7	9 x 14 x 15	5"	
SP0016-MM†	16 Gal	9	14 x 21 x 14	5"	
SP0020-OM†	20 Gal Upright	16	11 x 15 x 31	5"	1/2" outlet

APPLICATOR TANKS - SUMP ON BOTTOM

PART NO.	CAPACITY	WEIGHT	DIMENSIONS (width x length x height)	LID	FITTING
SP0008-VM†	8 Gal Loaf	6	12 x 16 x 17	5"	1/2" FPT BOSS
SP0012-RT†	12 Gal Rectangle	9	14 x 18 x 12	5"	3/4"
SP0012-VM†	12 Gal Loaf	9	12 x 16 x 22	5"	1/2" FPT BOSS
SP0019-VM†	19 Gal Loaf	15	12 x 16 x 28	5"	1/2" FPT BOSS
SP0020-LC†	20 Gal Rectangle	11	14 x 28 x 12	5"	3/4"



†indicates can be shipped via UPS/FedEx



UTILITY TANKS-FLAT BOTTOM

PART NO.	CAPACITY	WEIGHT	DIMENSIONS (width x length x height)	LID	FITTING
SP0026-RT†	26 Gal Rectangle	14	18 x 25 x 19	8"	3/4" outlet
SP0045-AS†	45 Gal Rectangle	22	18 x 37 x 22	5"	
SP0050-RT*	50 Gal Rectangle	25	19 x 38 x 23	8"	1"
SP0055-MM†	55 Gal Rectangle	30	18 x 18 x 44	5"	1"
SP0080-RT†	80 Gal Rectangle (Support Req.)	42	18 x 27 x 44	5"	1"
SP0100-RT*	100 Gal Rectangle	48	27 x 43 x 29	8"	1"
SP0150-RT*	150 Gal Rectangle	60	36 x 48 x 29	8"	1"
SP0200-RT*	200 Gal Rectangle	80	36 x 48 x 38	8"	1"
SP0250-UT	250 Gal Upright Rectangle	113	29 x 62 x 46	16"	1-1/2"
SP0400-UT	400 Gal Upright Rectangle	207	29 x 62 x 70	16"	2"



SP0055-MM

LOW PROFILE RECTANGLE TANKS

PART NO.	CAPACITY	WEIGHT	DIMENSIONS (width x length x height)	LID	FITTING
LP0050-RT*†	50 Gal Low Profile Rectangle	35	24 x 43 x 15	5"	1"
LP0068-RT*†	68 Gal Low Profile Rectangle	40	26 x 42 x 17	6"	1"
LP0110-RT*†	110 Gal Low Profile Rectangle	59	35 x 48 x 19	5"	1"

*Powder coated Steel Bands are available for these utility tanks.
Consult the price sheet for details.



LP0068-RT

LP0050-RT



5" Hinged Low-Profile Lid



LP0110-RT

RECTANGLE TANKS-TOTAL DRAIN *

PART NO.	CAPACITY	WEIGHT	DIMENSIONS (width x length x height)	LID	FITTING
SP0035-RT†	35 Gal Rectangle	17	19 x 28 x 20	5"	1"
SP0056-RT†	56 Gal Rectangle	30	20 x 38 x 26	5"	3/4"

*Sloped bottom for full drainage.

†indicates can be shipped via UPS/FedEx

SP0056-RT



SP0035-RT



PCO (PEST CONTROL OPERATOR) TANKS

PCO tanks can be selected for stationary or transportable (non DOT approved) applications both indoor and outdoors. The 50-300 gallon tanks have a rounded bottom for best fluid drainage. A 2" deep sump option is also available on these sizes. PCO tanks must be securely anchored for use in transportable applications and powder coated steel bands are available for this purpose. The tanks are manufactured from medium-density polyethylene with U.V. stabilizers and designed for containment of liquids of up to 1.7 specific gravity.



PART NO.	CAPACITY	WEIGHT	DIMENSIONS (width x length x height)	LID	FITTING
PCO035-16W [†]	35 Gallon	25	16 x 35 x 21	5"	1"
PCO050-19S [†]	50 Gallon w/sump	25	19 x 38 x 23	8"	1"
PCO050-19W [†]	50 Gallon	25	19 x 38 x 23	8"	1"
PCO100-30S	100 Gallon w/sump	50	30 x 38 x 29	8"	1"
PCO100-30W	100 Gallon	50	30 x 38 x 29	8"	1"
PCO150-37S	150 Gallon w/sump	61	37 x 48 x 29	12"	1-1/4"
PCO150-37W	150 Gallon	61	37 x 48 x 29	12"	1-1/4"
PCO200-37S	200 Gallon w/sump	82	37 x 48 x 38	12"	1-1/4"
PCO200-37W	200 Gallon	82	37 x 48 x 38	12"	1-1/4"
PCO300-37S	300 Gallon w/sump	160	37 x 69 x 40	16"	2"
PCO300-37W	300 Gallon	160	37 x 69 x 40	16"	2"

POWDER COATED STEEL BANDS

PART NO.	CAPACITY	WEIGHT	DIMENSIONS (width x length)
PC0035-SB [†] *	35 Gallon Set	3	2 x 50.5
PC0050-SBP [†]	50 Gallon Set	6	2.5 x 57.5
PC0100-SBP [†]	100 Gallon Set	10	2.5 x 76
PC0150-SBP [†]	150 Gallon Set	15	3.5 x 82
PC0200-SBP [†]	200 Gallon Set	18	3.5 x 98
PC0300-SBP [†]	300 Gallon Set	20	4 x 100

2 Bands Per Set [†]indicates can be shipped via UPS/FedEx

*PC0035 bands are stainless steel. All other sizes are powder coated silver.

PCO300-37



PCO300-37 comes with internal baffle for support and fluid control.

LIQUID FEEDER TANKS

These tanks are designed for dispensing liquid feed supplements to livestock. Tanks are equipped with rotary dispensing wheels and fill port. Tanks are manufactured from medium-density polyethylene with U.V. inhibitors and designed for containment of liquids of up to 1.5 specific gravity. Tank walls are translucent for level viewing and equipped with gallon indicators. Wheels sold separately.



PART NO.	CAPACITY	DESCRIPTION	WEIGHT	DIMENSIONS (diameter x height)
LTA155-55	155 Gallon	Uses up to three 24-inch wheels	60	50 x 38
LTA180-68	180 Gallon	Uses up to four 17-inch wheels	75	68 x 34
LTA285-68	285 Gallon	Uses up to four 24-inch wheels	98	68 x 39
<i>Wheels Sold Separately</i>				
LT17W		17-inch wheel	2	
LT24W		24-inch wheel	4	

LTA285-68

MISCELLANEOUS

Mineral Feeders feature a heavy metal base and pivot system to prevent mineral loss in wind. Polyethylene feeder housing is corrosion resistant with U.V. inhibitors. Mineral Feeder capacity is 100 lbs. and is U.S.D.A. compliant. Feed carts feature a polyethylene tub with a 3.5 bushel capacity. The metal frame is powder coated.



SJ-10183



MF-10198

PART NO.	CAPACITY	WEIGHT	DIMENSIONS (Assembled)
MF-10198†	100 lb Mineral Feeder	91	72 x 72 x 54
SJ-10183†	3.5 Bushel Feed Cart Standard	60	18 x 40 x 36
SJ10232†	3.5 Bushel Feed Cart Deluxe	65	18 x 40 x 36

FUEL TANKS

Typically used as a fuel tank on power equipment, these specialty tanks are manufactured from high-density cross-linked polyethylene with U.V. stabilizers and are available in natural and black colors. Tanks are designed for the containment of all chemicals (including gasoline and diesel fuels) rated for contact with cross-linked polyethylene. The standard weight tank is designed for chemicals with a specific gravity of 1.75. Tanks are provided with a collection sump on the bottom for fitting installation, but because of the variety of applications, **no fittings are furnished.** Please consult factory regarding available fittings.

PART NO.	CAPACITY	WEIGHT	DIMENSIONS (width x length x height)	LID
SP0006-FU†	6 Gal Fuel XLPE	5	10 x 15 x 10	2"
SP0006-FUWB†	6 Gal Fuel XLPE w/ 1/4" brass bulkhead	5	10 x 15 x 10	2"
SP0012-FU†	12 Gal Fuel XLPE	9	14 x 18 x 12	2"
SP0012-FUWB†	12 Gal Fuel XLPE w/ 1/4" brass bulkhead	9	14 x 18 x 12	2"

SP0012-FU

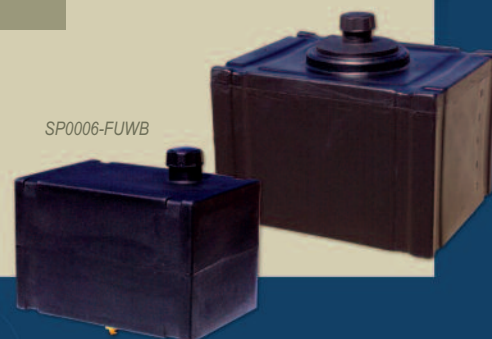

SP0006-FUWB

†indicates can be shipped via UPS/FedEx



TRACTOR MOUNTED TANKS

Tractor Mounted Tanks are designed as portable (non DOT approved) applicator tanks. Tanks require the bottom to be fully supported with a cradle for use. Gallon indicators are included and the tank walls are translucent for level viewing. Ends of tanks feature fitting flats to facilitate a variety of installation options. Bottom of tanks feature a collection sump for full drain out. Tanks are manufactured from medium-density polyethylene with U.V. inhibitors and designed for containment of liquids of up to 1.7 specific gravity.

OVAL TANKS

PART NO.	CAPACITY	WEIGHT	DIMENSIONS (width x length x height)	LID	FITTING
OT0300-31	300 Gallon Oval	100	31 x 49 x 56	16"	3/4" & 1-1/4"

TEAR DROP TANKS

PART NO.	CAPACITY	WEIGHT	DIMENSIONS (width x length x height)	LID	FITTING
TD0250-36	250 Gallon	97	36 x 52 x 45	12"	3/4" & 1-1/4"
TD0300-36	300 Gallon	109	36 x 62 x 45	12"	3/4" & 1-1/4"



CRADLES

PART NO.	CAPACITY	WEIGHT	BANDS
TD0250-C	250 Gallon	96	2.5" x 74.5"
TD0300-C	300 Gallon	108	2.5" x 74.5"

CUT-AWAY APPLICATOR TANKS

PART NO.	CAPACITY	WEIGHT	DIMENSIONS (width x length x height)	LID	FITTING
CAW0200-24	200 Gallon	80	24 x 55 x 46	8"	3/4" & 1-1/4"
CAW0250-24	250 Gallon	95	24 x 61 x 51	8"	3/4" & 1-1/4"

CUT-AWAY CRADLES

PART NO.	CAPACITY	WEIGHT	BANDS
CAW0200-C	200 Gallon	135	3" x 60"; 3" x 40"
CAW0250-C	250 Gallon	143	3" x 72"; 3" x 51"

CAW0250-24/CAW0250-C



CROP CARE TANKS

Crop Care Tanks are designed for OEM sprayer applications that contain chemicals rated for contact with polyethylene. Hoop recesses are provided around the tank to facilitate installation and anchoring. Wide bottom tanks are available with either box-style or sloped-style sump on the bottom for withdrawal. Narrow bottom tanks are cutout on each side to facilitate narrow track widths and are only available with a sloped-style sump. Larger tanks are furnished with polyethylene baffles for fluid control and a five-gallon rinse tank. The tanks are manufactured from high-density polyethylene with U.V. stabilizers and are designed for liquids of up to 1.9 specific gravity.

CC1500-58S



Cradles/skids shown for photo purpose only.
Not available for sale.



PART NO.	CAPACITY	WEIGHT	DIMENSIONS (width x length x height)	LID	FITTING
CM0500-48	500 Gallon w/ sump	202	48 x 90 x 38	16"	2"
CM0750-48	750 Gallon w/ sump	262	48 x 90 x 50	16"	2"
CC1000-58S*	1000 Gallon w/ sloped sump	305	58 x 115 x 47	16"	2"
CC1000-58N*	1000 Gallon narrow bottom w/ sloped sump	305	58 x 115 x 51	16"	2"
CM1000-58B*	1000 Gallon w/ box sump	305	58 x 115 x 47	16"	2"
CC1250-58S*	1250 Gallon w/ sloped sump	432	58 x 115 x 57	16"	2"
CC1250-58N*	1250 Gallon narrow bottom w/ sloped sump	432	58 x 115 x 61	16"	2"
CM1250-58B*	1250 Gallon w/ box sump	432	58 x 115 x 57	16"	2"
CC1500-58S*	1500 Gallon w/ sloped sump	483	58 x 115 x 66	16"	2"
CC1500-58N*	1500 Gallon narrow bottom w/ sloped sump	483	58 x 115 x 70	16"	2"
CM1500-58B*	1500 Gallon w/ box sump	483	58 x 115 x 66	16"	2"

*Baffles & rinse tank included.
Tanks are shipped on returnable pallet. Fittings are shipped loose.

A 5-gallon rinse tank is included with larger Crop Care tanks.

HOOPS

PART NO.	CAPACITY	KIT
CC0500-HPS	500 Gallon Hoop	1 Hoop 1 2/3" pipe
CC0750-HPS	750 Gallon Hoop	1 Hoop 1 2/3" pipe
CC1000-HP	1000 Gallon Hoops	1 Set 3 - 2 3/8" pipes
CC1250-HP	1250 Gallon Hoops	1 Set 2 - 2 3/8" pipes
CC1500-HP	1500 Gallon Hoops	1 Set 5 - 2 3/8" pipes



ACCESSORY PARTS

(All accessory parts can be shipped via UPS/FedEx)

FITTINGS

DHI's Injection Division manufactures a wide variety of accessories, lids and fittings to meet the needs of our customers. Our polypropylene bulkhead fittings incorporate an innovative design that is proven to last.



10912

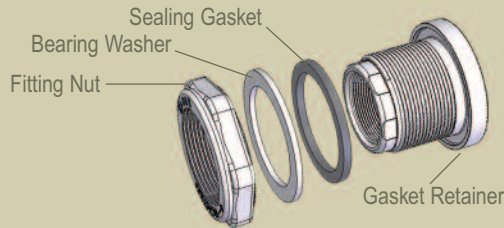

Features ...

- Retainer ring molded into each fitting prevents the sealing gasket from expanding or sliding out of position under compression.
- Bearing washer insures even compression on the gasket and promotes sealing.
- Each fitting features left hand compression threads to prevent loosening while installing mating fittings.
- Internal threads feature female pipe threads and are provided on both sides of the fitting - mating fittings can be installed on both sides of the installed fitting.
- Sealing gaskets are produced from durable Santoprene thermoplastic rubber (TPR).
- Fitting compression nuts feature a specially designed cross-section to prevent distortion under load.

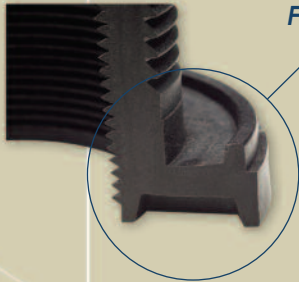

BULKHEAD FITTINGS & SYPHON TUBES

PART NO.	DESCRIPTION	HOLE REQUIREMENT
10897	1/4" Brass Bulkhead	25/32"
10058	1/2" Ace Bulkhead	1 1/4"
10025	1/2" Polypropylene Bulkhead	1 3/8"
10484	3/4" Ace Bulkhead	1 3/4"
10501	3/4" Polypropylene Bulkhead	1 3/8"
10485	1" Ace Bulkhead	1 3/4"
10503	1" Polypropylene Bulkhead	2 1/4"
10918	1-1/4" Ace Bulkhead	2 1/4"
10507	1-1/2" Ace Bulkhead	3"
10508	2" Ace Bulkhead	3"
10486	2" Stainless Steel Bulkhead Double Threaded	3"
10912	2" Ace Heavy Duty Bulkhead for tanks over 3000 gal	3 1/4"
10490	2" Stainless Steel Bulkhead Heavy for tanks over 3000 gal	3 1/4"
12528	3" Ace Bulkhead	4 1/2"
10487	3" Stainless Steel Bulkhead Double Threaded	4 1/2"
10511	2" Syphon Tube	
10488	2" Long Syphon Tube	
10489	3" Long Syphon Tube	



19444

10897

10058

10484

10485

10508

10507

10511

12528

10912

10488

10489

10487

ACCESSORY CLIPS

PART NO.	DESCRIPTION
19444	Accessory Clip
12100	Accessory Clip Kit (includes 2 Accessory Clips & 2 screws packaged in zip seal bag)

* Other packaging options can be quoted per request.
* Various packaging options are available to meet your needs.

LIDS

These durable lids are available in a wide range of sizes from 2" to 22". Most are available with or without venting to suit your applications. Injection molded from polypropylene with U.V. inhibitors ensures long life.



19024 & 19025



12460

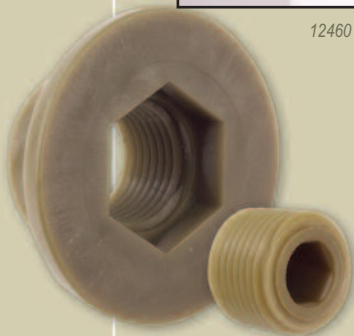

3/8" Threaded Spinweld & Plug

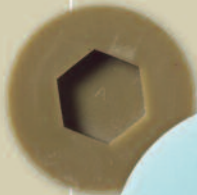

10008
1" Patch



12429
1 1/2" Patch



10441
2" Patch

PART NO.	DESCRIPTION
10631	2" Spin-on Kelch Cap
10523	5" Spin-on Non-Vented Lid
10522	5" Spin-on Spring-Vented Lid
12110	5" Spin-on Lid w/ Step Vent
19406	5" Hinged Low-Profile Lid
12415	7" Spin-on Non-Vented Lid
12414	7" Spin-on Spring-Vented Lid
12427	7" Spin-on Lid w/ Step Vent
10525	8" Threaded Vented Lid & Ring
10526	12" Threaded Non-Vented Lid & Ring
10527	12" Threaded Vented Lid & Ring
10528	16" Threaded Vented Lid & Ring
10530	22" Threaded Vented Lid & Ring
10520	Breather Only (for 8" & 12" lids)
10529	Breather, 4" Center (for 16" lid)
12460	Self-Anchoring Lanyard - 12"
10873	Short Lanyard - 12"
10534	Long Lanyard - 16"
19024	Outlet Cap, 3/4"
19025	Tether for Outlet Cap
10960	Gasket for Outlet Cap

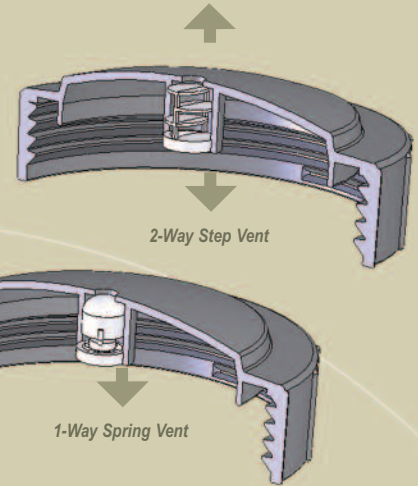
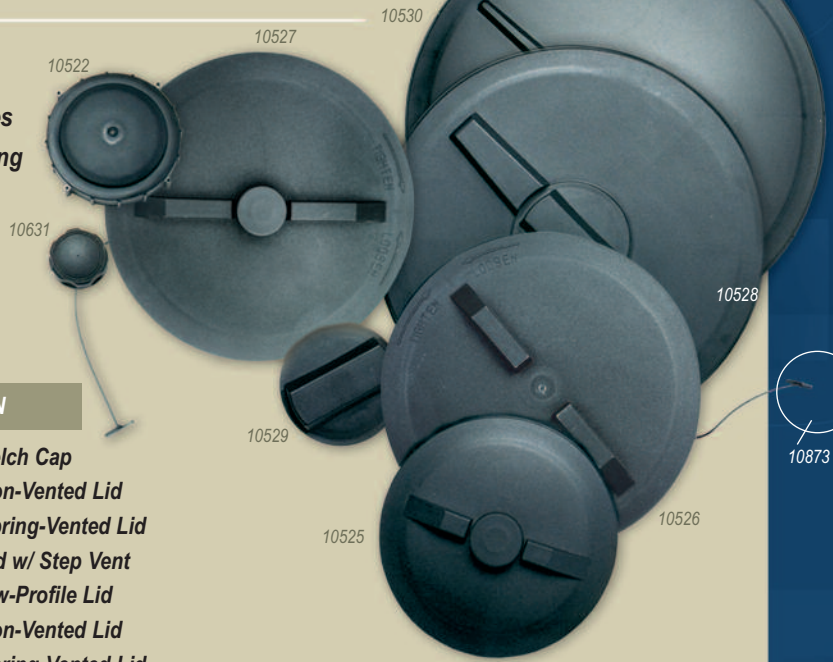

SPINWELDS

DHI spinwelds feature a hex driving recess to ease installation. This driving recess makes the installation tools universal and easy to construct. These spinwelds also feature a specially designed conical welding surface that helps to center the spinweld and increases the surface welding area.

PART NO.	DESCRIPTION
10237	3/8" Threaded Plug
10041	3/8" Threaded Spinweld
12104	3/4" Patch (9/16" Hex Drive)
10008	1" Patch (3/4" Hex Drive)
12429	1 1/2" Patch (3/4" Hex Drive)
10441	2" Patch (3/4" Hex Drive)

* Black part numbers listed.
* Call for quote on custom colors.



10041 - 3/8" Threaded Spinweld

2" Patch showing conical welding surface

SEPTIC/CISTERN

Septic Tanks are designed and manufactured to meet wastewater treatment system standards. Cistern water tanks are designed for bulk storage or collection of potable water. Manufactured from high-density polyethylene with U.V. inhibitors, tanks are designed for containment of liquids up to 1.7 specific gravity. Tanks feature deep ribbing for strength to permit below-ground installations of up to 36" depths. The 1000, 1250, and 1500 gallon double-compartment septic tanks have been tested by NSF to meet the IAPMO Z1000 and CAN/CSA-B-66 standards. Consult with the applicable state, county or local codes for polyethylene septic tank compliance and installation requirements.



Divider panel

SEPTIC TANKS

PART NO.	CAPACITY	DESCRIPTION	WEIGHT	DIMENSIONS (width x length x height)
AST-0300-1	300 Gallon	Pump Tank w/ One Access Cover	134	54 x 56
AST-0500-1	500 Gallon	Pump Tank w/ One Access Cover	197	63 x 74
AST-0750-1	750 Gallon	Single Compartment w/ One Access Cover	259	60 x 70 x 60
AST-1000-1	1000 Gallon	Single Compartment w/ Two Access Covers	390	60 x 101 x 60
AST-1000-2	1000 Gallon	Double Compartment w/ Two Access Covers	436	60 x 101 x 60
AST-1250-1	1250 Gallon	Single Compartment w/ Two Access Covers	443	58 x 118 x 72
AST-1250-2	1250 Gallon	Double Compartment w/ Two Access Covers	489	58 x 118 x 72
AST-1500-1	1500 Gallon	Single Compartment w/ Two Access Covers	528	58 x 137 x 72
AST-1500-2	1500 Gallon	Double Compartment w/ Two Access Covers	574	58 x 137 x 72

AST-1500-2



AST-1250-2

AST-0300-1

AST-0500-1

CISTERN TANKS

PART NO.	CAPACITY	DESCRIPTION	WEIGHT	DIMENSIONS (width x length x height)
AST-0325-1W	325 Gallon	Cistern Tank	134	54 x 56
AST-0525-1W	525 Gallon	Cistern Tank	194	63 x 74
AST-0850-1W	850 Gallon	Cistern Single Compartment	259	60 x 70 x 60
AST-1150-1W	1150 Gallon	Cistern Single Compartment	414	60 x 101 x 60
AST-1450-1W	1450 Gallon	Cistern Single Compartment	473	58 x 118 x 72
AST-1700-1W	1700 Gallon	Cistern Single Compartment	567	58 x 137 x 72

AST-1700-1W



AST-0325-1W

AST-0525-1W

AST19366
Green 24" Access Cover

SEPTIC/CISTERN TANK ACCESSORIES

EXCLUSIVE LID DESIGN

Only Ace Tanks have double-walled access covers that lock securely to the tank body and can be secured using nylon ties, eliminating the need for metal fasteners that can corrode and fail. They feature a custom-molded gasket in the lid. Manufactured from extruded Nitrile Rubber, the gasket snaps into the lid to make a watertight seal.



Stop Bead
Gasket Seal
Back-up Dam



AST19213
Cistern 24" Access Cover

AST19211
Septic 24" Access Cover

AST19365
Septic 7" Extension

AST19257
Septic 8" Riser & Lid

AST19258
Cistern 8" Riser & Lid

AST19212
Septic 16" Extension

AST19214
Cistern 16" Extension





Den Hartog

INDUSTRIES, INC.

ABOUT US

A reflection on the company's history shows that the same values that founded the company drive the business today.

John J. and Ann Den Hartog purchased J & J Hardware in Hospers, IA, in 1966. For 10 years they enjoyed serving the community but decided that they would like to do even more. On February 9, 1976 they purchased H & S Manufacturing.

Their beginnings with H & S Mfg. consisted of 6 employees and 3 acres of land. They fabricated metal products for hog operations under the Sowjoy brand. Soon after that the couple decided to further expand their business by purchasing VW Dock Company in 1977. VW Dock had been a customer who produced boat docks. It was this transition that helped to lead the company into plastics with the desire to expand into float drums.

In March of 1990 the company entered into plastic manufacturing with the launch of Ace Roto-Mold Manufacturing, rotationally molding storage tanks for agricultural and industrial use as well as float drums. They also began molding custom parts for customers in various industries. The VW Dock portion of the business was sold in 1993 but today the Ace Roto-Mold division continues to produce a whole line of marine products including float drums and dock cushions.

The Den Hartogs continued to expand by adding the Ace Injection Molding facility in 1995. Today the Injection Molding division makes lids and fittings for the Ace Roto-Mold tanks as well as a variety of specialized products for an expanding list of industries.

John J. and Ann always encouraged their children to be involved with the company. In 1998 they were able to pass their growing business to their children, John G. Den Hartog, Barb Truesdell, and Julie Henrich. The second generation of Den Hartogs incorporated H & S Mfg. and Ace Roto-Mold under one name, Den Hartog Industries, Inc. John G. Den Hartog, President, along with Paul Truesdell, Vice President and Jerry Henrich, Corporate Secretary/Treasurer, are leading the company into the future.

In 2000, Den Hartog Industries, Inc. took another step by adding the Blow Molding division, which added a third type of plastic processing to its capabilities. They also launched the Ace Dock Accessories brand in 2004, bringing marine products to the retail market.

Today Den Hartog Industries' four divisions - Ace Roto-Mold, Blow Molding, Injection Molding and Sowjoy - employ over 300 people in facilities in excess of 365,000 sq feet. The company-owned fleet of trucks distributes products nation wide and into Canada. The company continues to expand its product offerings and widen its distribution network each year. Den Hartog Industries, Inc. will always be committed to serving its customers and community by being **"Always At Your Service."**



NEW FROM ACE ROTO-MOLD

LP0110-RT



See Low Profile Tanks on page 19.

LP0050-RT



See Open Top Containment Tanks on page 13.

OP0825-RT

OP0625-RT w/FS0535-48



See Stackable Totes on page 17.

See Elliptical Tanks on page 9.

HE1250-78



See Water Only Tanks on page 16.

WO3000-VT

SB00060



See Blow Molded Applicator Tanks on page 12.

SB00040

ST0070-32



Den Hartog
INDUSTRIES, INC.

4010 Hospers Drive South • P.O. Box 425 • Hospers, IA 51238-0425
(712) 752-8432 • (800) 342-3408 • FAX (712) 752-8222

www.denhartogindustries.com

(Catalog Code: D06/09)