

© DEN HARTOG INDUSTRIES, INC.

Copyright. All information furnished within this document, electronic file or design correspondence is the property of Den Hartog Industries, Inc. and shall not be used, disclosed to others or copied without the expressed written consent of Den Hartog Industries, Inc.

KEY	PART NUMBER	DESCRIPTION	MATERIAL
1	DCBM3-2.50-BK HDPE	CUSHION, 3 FT BLACK	80041
2	DCBM3-2.50-WE HDPE	CUSHION, 3 FT WHITE	80006

DCBM3-2.50

G

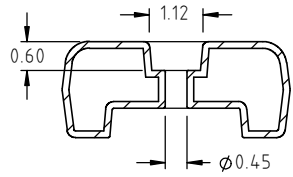

SECTION B-B  
SCALE 1:4

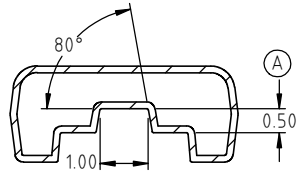

SECTION A-A  
SCALE 1:4

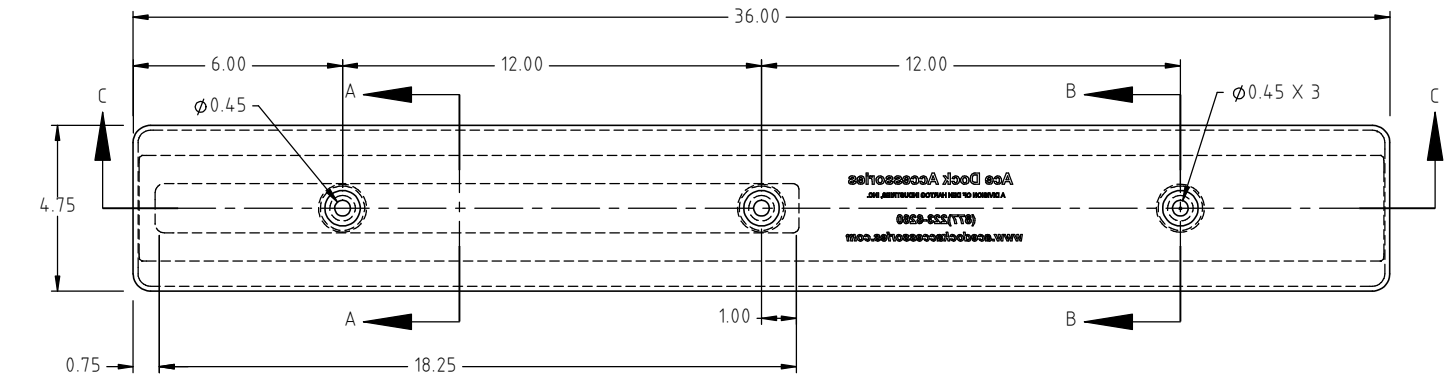
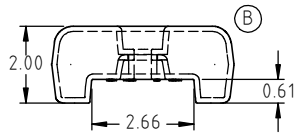

FLATNESS OF FRONT OR BACK SURFACES TO BE WITHIN 0.50"

SECTION C-C  
SCALE 1:5.5

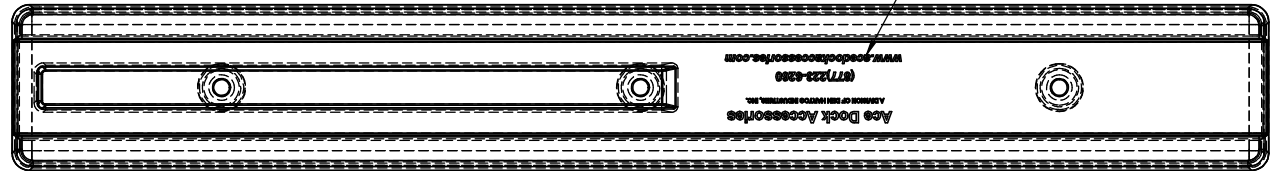
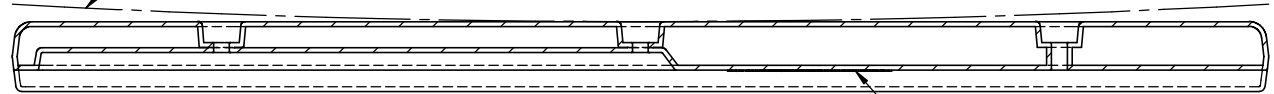

G	FIXED SECTION VIEWS, ADDED MATERIAL CHART, UPDATED PRINT	HLN	2/17/2021	4091	DRAWN / DATE	MATERIAL
F	MATERIAL ADDED TO PRINT, MATERIAL UPDATED	HLN	4/8/2020	3941	REH 2/3/2003	SEE TABLE
E	MATERIAL ADDED TO PRINT	ADH	7/15/2015	3097	APPRD. / DATE	
REV.	DESCRIPTION	BY	DATE	CCN	REH 2/3/2003	
ALL DIMENSIONS ARE IN DECIMAL INCHES TOLERANCES UNLESS OTHERWISE SPECIFIED		THIRD ANGLE PROJECTION ANSI 14.5M			SHOT WEIGHT: 2.0 LBS	NOTES: 1.) NOM. WALL @ .140 2.) BLACK OR WHITE COLOR 3.) COMPOUNDED U.V. INHIBITOR
POLYETHYLENE	METAL DECIMAL ± .125" FRACTION ± 1/4" ANGLE ± 1°			SHIPPING WEIGHT:		
±1% @ 68°F					FINISH:	

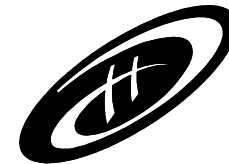

**Den Hartog**  
**INDUSTRIES, INC.**

Ace Roto-Mold • Injection Molding • Blow Molding • Sowjoy  
4010 HOSPERS DRIVE S. BOX 425, HOSPERS, IOWA 51238-0425

DESCRIPTION	BLOW-MOLDED 2.50" GROOVE BACK CUSHION-3 FEET LONG		
SCALE	N.S.	PART NO.	DCBM3-2.50
SHEET	1 OF 1		