

Copyright. All information furnished within this document, electronic file or design correspondence is the property of Den Hartog Industries, Inc. and shall not be used, disclosed to others or copied without the expressed written consent of Den Hartog Industries, Inc.

KEY	PART NUMBER	DESCRIPTION	QTY.
1	FS1800-SKW-1	SIDE CHANNEL	2
2	FS1800-SKW-2	MIDDLE CHANNEL	8
3	FS1800-SKW-3	CENTER SUPPORT PLATE	1
4	FS1800-SKW-4	SUPPORT PLATE	2
5	FS1800-SKW-5	SUPPORT FLAT BAR	2
6	FS1800-SKW-6	OUTSIDE SUPPORT FLAT BAR	2
7	FS1800-SKW-7	OUTSIDE SUPPORT PLATE	2
8	12411	5" X 5" GUSSET	4

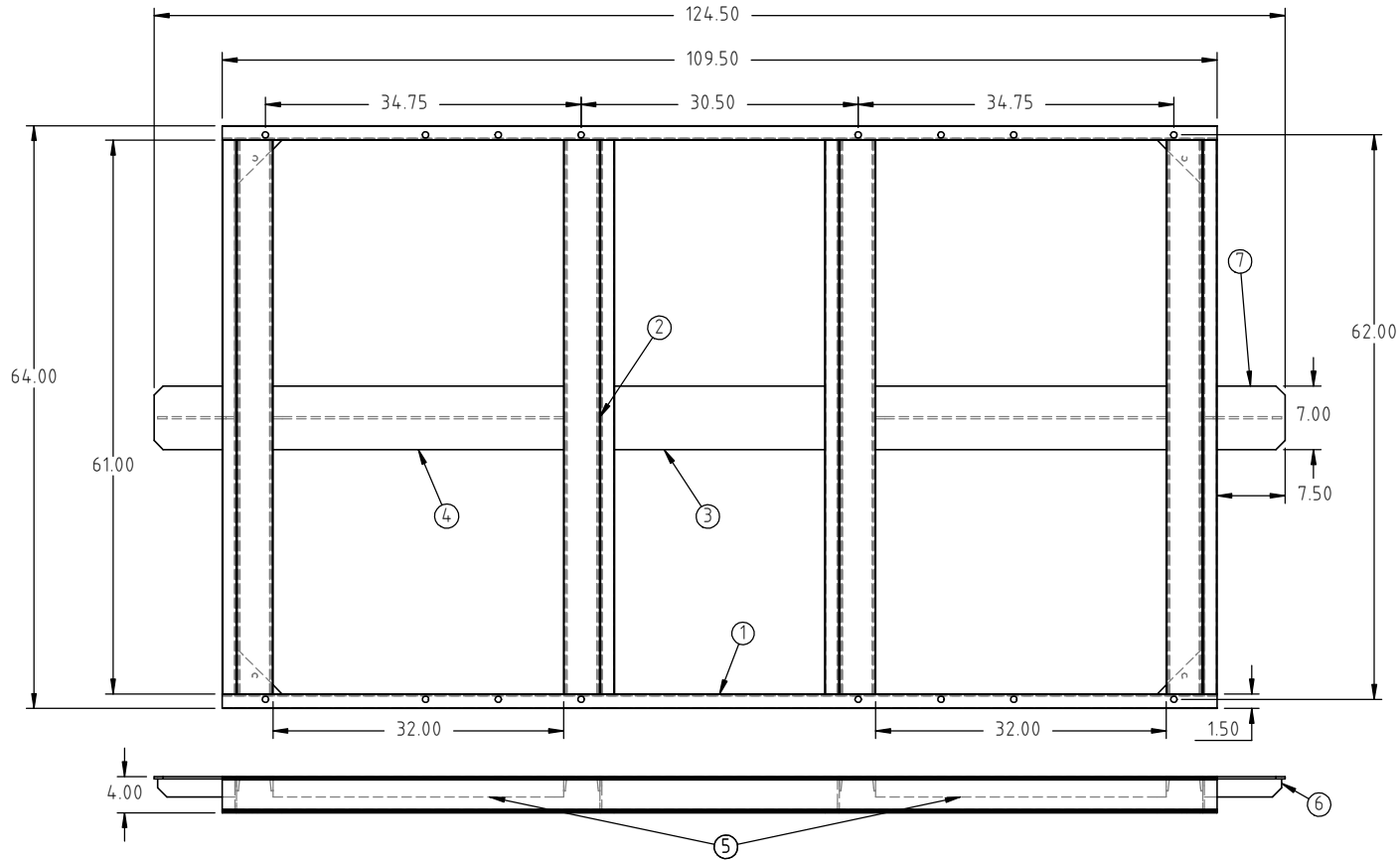

				DRAWN / DATE DHJ 10/15/04	MATERIAL
A	BOM TABLE ADDED TO PRINT	ADH 6/23/17	3401	APPRD. / DATE ADH 11/9/07	
REV	DESCRIPTION	BY / DATE	CCN		
ALL DIMENSIONS ARE IN DECIMAL INCHES TOLERANCES UNLESS OTHERWISE SPECIFIED		THIRD ANGLE PROJECTION ANSI 14.5M		SHOT WEIGHT:	NOTES:
POLYETHYLENE		METAL DECIMAL ± .125" FRACTION ± 1/4" ANGLE ± 1°		SHIPPING WEIGHT:	
±1% @ 68°F				FINISH:	



Den Hartog
INDUSTRIES, INC.

Acra Roto-Mold Injection Molding Blow Molding Sowjoy

4010 HOSPERS DRIVE S. BOX 425, HOSPERS, IOWA 51238-0421

DESCRIPTION	FS, SKID 1800 GALLON WITHOUT SUMP	
SCALE	N.S.	PART NO. FS1800-SKW

Copyright. All information furnished within this document, electronic file or design correspondence is the property of Den Hartog industries, Inc. and shall not be used, disclosed to others or copied without the expressed written consent of Den Hartog Industries, Inc.

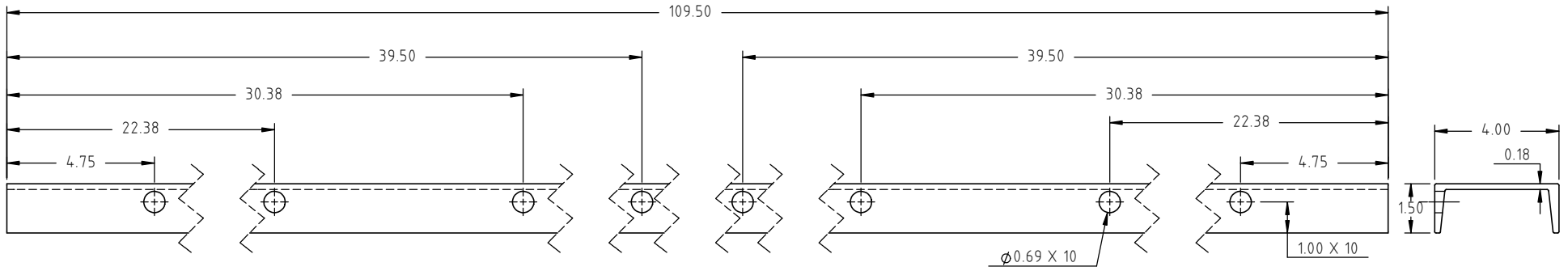

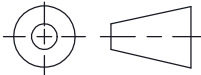
				DRAWN / DATE ADH 3/20/09	MATERIAL 1.) CHANNEL, 4", MILD STEEL	 <p>Den Hartog INDUSTRIES, INC.</p> <p><i>Acc Roto-Mold Injection Molding Blow Molding Sowjoy</i></p> <p>4010 HOSPERS DRIVE S. BOX 425, HOSPERS, IOWA 51238-0421</p>
				APPROD. / DATE KGJ 6/23/17		
REV	DESCRIPTION	BY / DATE	CCN			
ALL DIMENSIONS ARE IN DECIMAL INCHES TOLERANCES UNLESS OTHERWISE SPECIFIED POLYETHYLENE $\pm 1\%$ @ 68°F		THIRD ANGLE PROJECTION ANSI 14.5M 		SHOT WEIGHT:	NOTES:	DESCRIPTION FS,1800, GALLON TANK SKID, SIDE CHANNEL
				SHIPPING WEIGHT:		
				FINISH:		

Copyright. All information furnished within this document, electronic file or design correspondence is the property of Den Hartog industries, Inc. and shall not be used, disclosed to others or copied without the expressed written consent of Den Hartog Industries, Inc.

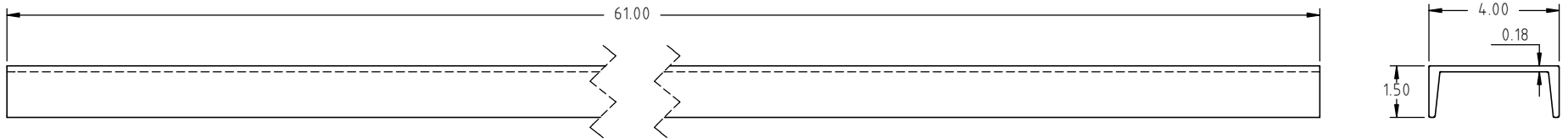

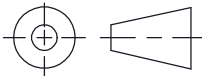
				DRAWN / DATE ADH 3/20/09	MATERIAL 1.) CHANNEL, 4", MILD STEEL	 <p>Den Hartog INDUSTRIES, INC.</p> <p><i>Acc Roto-Mold Injection Molding Blow Molding Sowjoy</i></p> <p>4010 HOSPERS DRIVE S. BOX 425, HOSPERS, IOWA 51238-0421</p>
				APPROD. / DATE KGJ 6/23/17		
REV	DESCRIPTION	BY / DATE	CCN			
ALL DIMENSIONS ARE IN DECIMAL INCHES TOLERANCES UNLESS OTHERWISE SPECIFIED		THIRD ANGLE PROJECTION ANSI 14.5M		SHOT WEIGHT:	NOTES:	DESCRIPTION FS,1800, GALLON TANK SKID, MIDDLE CHANNEL
POLYETHYLENE ±1% @ 68°F				SHIPPING WEIGHT:		
METAL DECIMAL ± .125" FRACTION ± 1/4" ANGLE ± 1°				FINISH:		
					SCALE N.S.	PART NO. FS1800-SKW-2

Copyright. All information furnished within this document, electronic file or design correspondence is the property of Den Hartog Industries, Inc. and shall not be used, disclosed to others or copied without the expressed written consent of Den Hartog Industries, Inc.

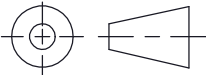

				DRAWN / DATE ADH 3/23/09	MATERIAL 1.) SHEET, 1/4 " MILD STEEL	 <p>Den Hartog INDUSTRIES, INC. <i>Acra Roto-Mold Injection Molding Blow Molding Sowjoy</i></p> <p>4010 HOSPERS DRIVE S. BOX 425, HOSPERS, IOWA 51238-0421</p>	
				APPROD. / DATE KGJ 6/23/17			
REV	DESCRIPTION	BY / DATE	CCN				
ALL DIMENSIONS ARE IN DECIMAL INCHES TOLERANCES UNLESS OTHERWISE SPECIFIED		THIRD ANGLE PROJECTION ANSI 14.5M		SHOT WEIGHT:	NOTES:	DESCRIPTION FS, 1800 GALLON TANK SKID, CENTER SUPPORT PLATE	
POLYETHYLENE	METAL DECIMAL ± .125" FRACTION ± 1/4" ANGLE ± 1°			SHIPPING WEIGHT:		SCALE N.S.	PART NO. FS1800-SKW-3
±1% @ 68°F				FINISH:			

Copyright. All information furnished within this document, electronic file or design correspondence is the property of Den Hartog industries, Inc. and shall not be used, disclosed to others or copied without the expressed written consent of Den Hartog Industries, Inc.

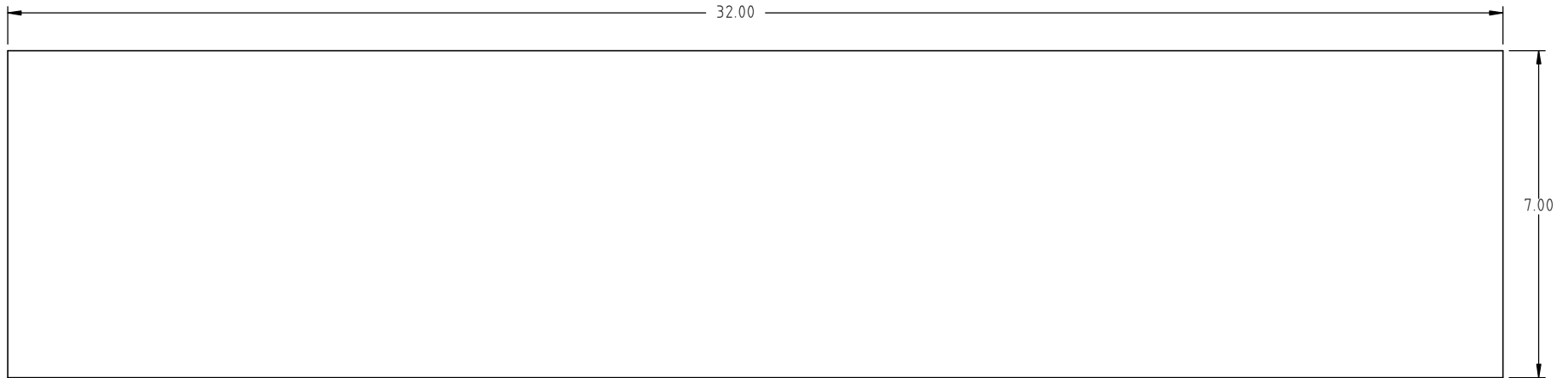

				DRAWN / DATE ADH 3/23/09	MATERIAL 1.) SHEET, 1/4 " MILD STEEL
				APPRD. / DATE KGJ 6/23/17	
REV	DESCRIPTION	BY / DATE	CCN		
ALL DIMENSIONS ARE IN DECIMAL INCHES TOLERANCES UNLESS OTHERWISE SPECIFIED		THIRD ANGLE PROJECTION ANSI 14.5M		SHOT WEIGHT:	NOTES:
POLYETHYLENE	METAL DECIMAL ± .125" FRACTION ± 1/4" ANGLE ± 1°			SHIPPING WEIGHT:	
±1% @ 68°F				FINISH:	



Den Hartog
INDUSTRIES, INC.

Acra Roto-Mold Injection Molding Blow Molding Sowjoy

4010 HOSPERS DRIVE S. BOX 425, HOSPERS, IOWA 51238-0421

DESCRIPTION FS, 1800 GALLON TANK SKID, SUPPORT PLATE	
SCALE N.S.	PART NO. FS1800-SKW-4

Copyright. All information furnished within this document, electronic file or design correspondence is the property of Den Hartog industries, Inc. and shall not be used, disclosed to others or copied without the expressed written consent of Den Hartog Industries, Inc.

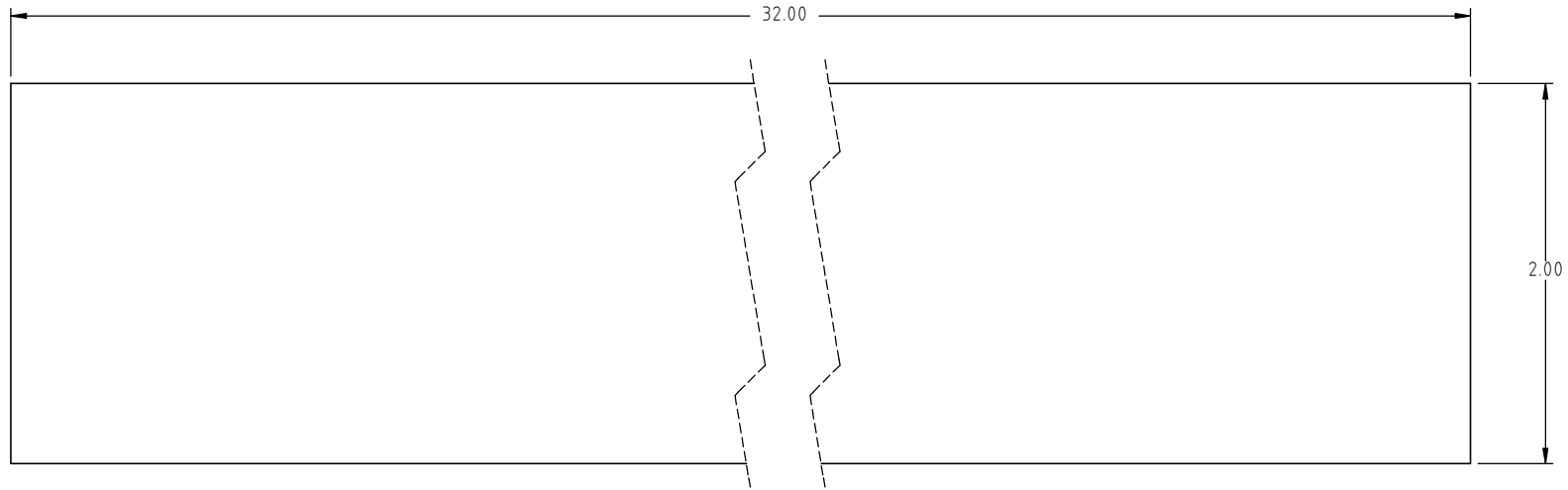

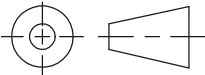
				DRAWN / DATE ADH 3/23/09	MATERIAL 1.) FLAT, 1/4 "X 2" MILD STEEL	 <p>Den Hartog INDUSTRIES, INC.</p> <p><i>Acc Roto-Mold Injection Molding Blow Molding Sowjey</i></p> <p>4010 HOSPERS DRIVE S. BOX 425, HOSPERS, IOWA 51238-0421</p>
				APPRD. / DATE KGJ 6/23/17		
REV	DESCRIPTION	BY / DATE	CCN			
ALL DIMENSIONS ARE IN DECIMAL INCHES TOLERANCES UNLESS OTHERWISE SPECIFIED POLYETHYLENE $\pm 1\%$ @ 68°F		THIRD ANGLE PROJECTION ANSI 14.5M 		SHOT WEIGHT:	NOTES:	DESCRIPTION FS, 1800 GALLON TANK SKID, SUPPORT FLAT BAR
				SHIPPING WEIGHT:		SCALE N.S.
				FINISH:		PART NO. FS1800-SKW-5

Copyright. All information furnished within this document, electronic file or design correspondence is the property of Den Hartog Industries, Inc. and shall not be used, disclosed to others or copied without the expressed written consent of Den Hartog Industries, Inc.

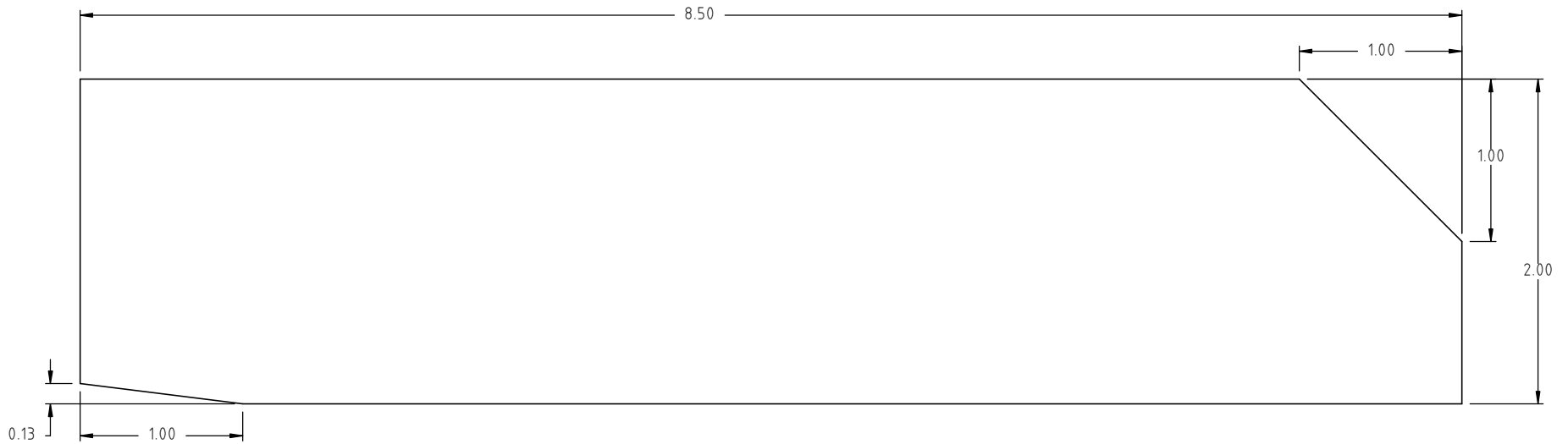

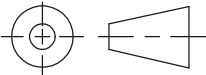
				DRAWN / DATE ADH 3/23/09	MATERIAL 1.) FLAT, 1/4 "X 2" MILD STEEL	 <p>Den Hartog INDUSTRIES, INC.</p> <p><i>Acra Roto-Mold Injection Molding Blow Molding Sowjoy</i></p> <p>4010 HOSPERS DRIVE S. BOX 425, HOSPERS, IOWA 51238-0421</p>	
				APPROD. / DATE KGJ 6/23/17			
REV	DESCRIPTION	BY / DATE	CCN				
ALL DIMENSIONS ARE IN DECIMAL INCHES TOLERANCES UNLESS OTHERWISE SPECIFIED		THIRD ANGLE PROJECTION ANSI 14.5M		SHOT WEIGHT:	NOTES:	DESCRIPTION FS, 1800 GALLON TANK SKID, OUTSIDE SUPPORT FLAT BAR	
POLYETHYLENE	METAL DECIMAL ± .125" FRACTION ± 1/4" ANGLE ± 1°			SHIPPING WEIGHT:		SCALE N.S.	PART NO. FS1800-SKW-6
±1% @ 68°F				FINISH:			

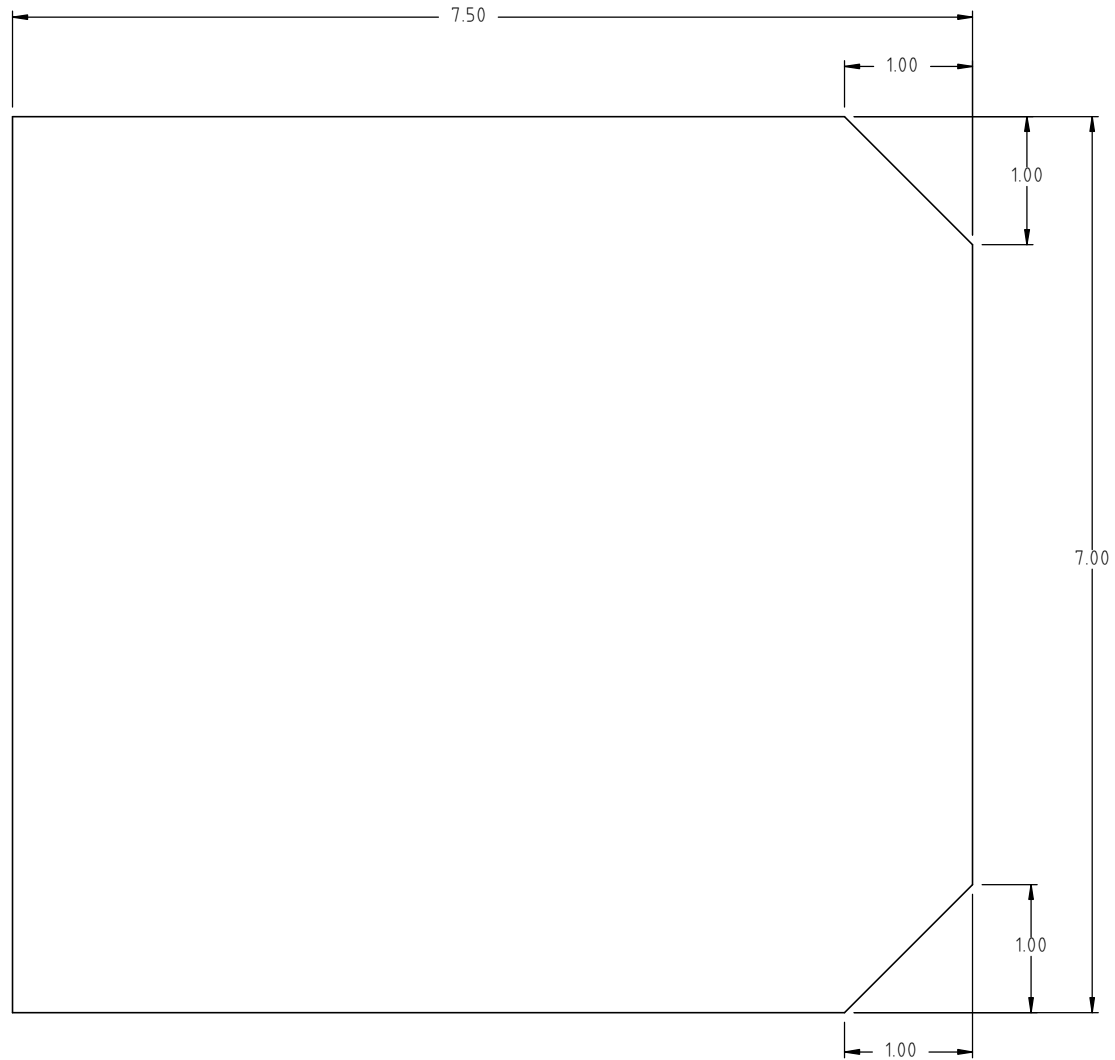

				DRAWN / DATE ADH 3/23/09	MATERIAL 1.) SHEET, 1/4 " MILD STEEL
				APPRD. / DATE KGJ 6/23/17	
REV	DESCRIPTION	BY / DATE	CCN		
ALL DIMENSIONS ARE IN DECIMAL INCHES TOLERANCES UNLESS OTHERWISE SPECIFIED		THIRD ANGLE PROJECTION ANSI 14.5M		SHOT WEIGHT:	NOTES:
POLYETHYLENE	METAL DECIMAL ± .125" FRACTION ± 1/4" ANGLE ± 1°			SHIPPING WEIGHT:	
±1% @ 68°F				FINISH:	



Den Hartog
INDUSTRIES, INC.

Acra Roto-Mold Injection Molding Blow Molding Sowjoy

4010 HOSPERS DRIVE S. BOX 425, HOSPERS, IOWA 51238-0421

DESCRIPTION FS, 1800 GALLON TANK SKID, OUTSIDE SUPPORT PLATE	
SCALE N.S.	PART NO. FS1800-SKW-7

© DEN HARTOG INDUSTRIES, INC.

Copyright. All information furnished within this document, electronic file or design correspondence is the property of Den Hartog Industries, Inc. and shall not be used, disclosed to others or copied without the expressed written consent of Den Hartog Industries, Inc.

FS1800-SKW

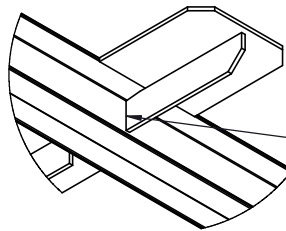
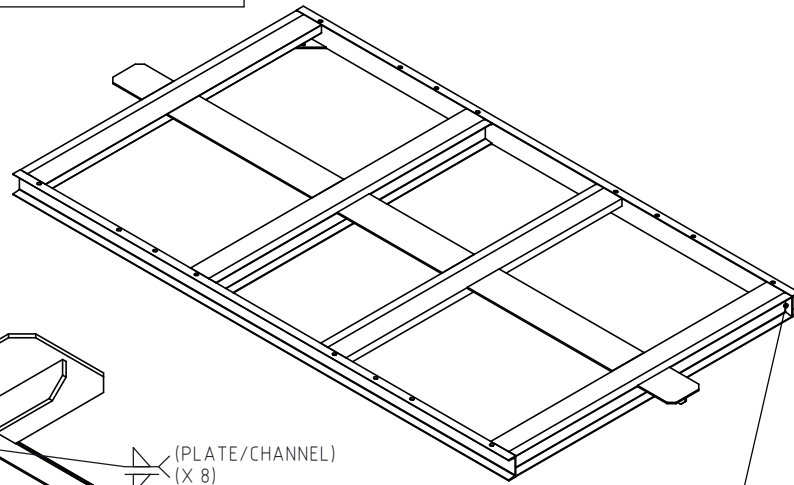

(PLATE/CHANNEL)
(X 8)

(CHANNEL/CHANNEL)
(X 8)

DETAIL A
SCALE 1 : 10

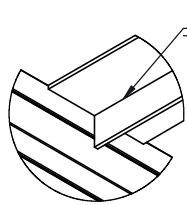

(PLATE / FLAT BAR)
(X 5)

DETAIL B
SCALE 1 : 10

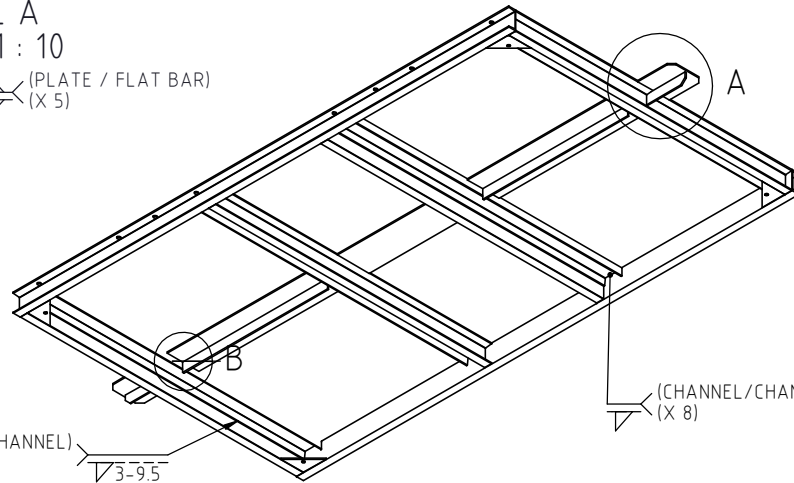

(CHANNEL/CHANNEL)
(X 4)

3-9.5

(CHANNEL/CHANNEL)
(X 8)

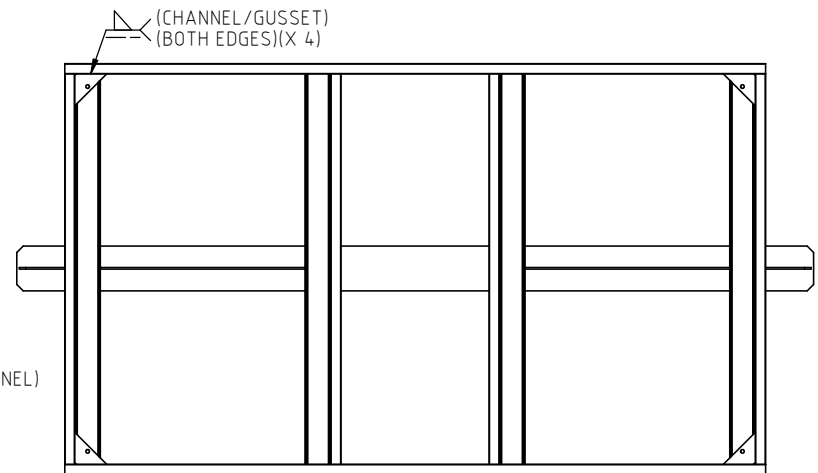
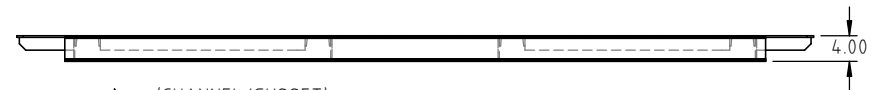
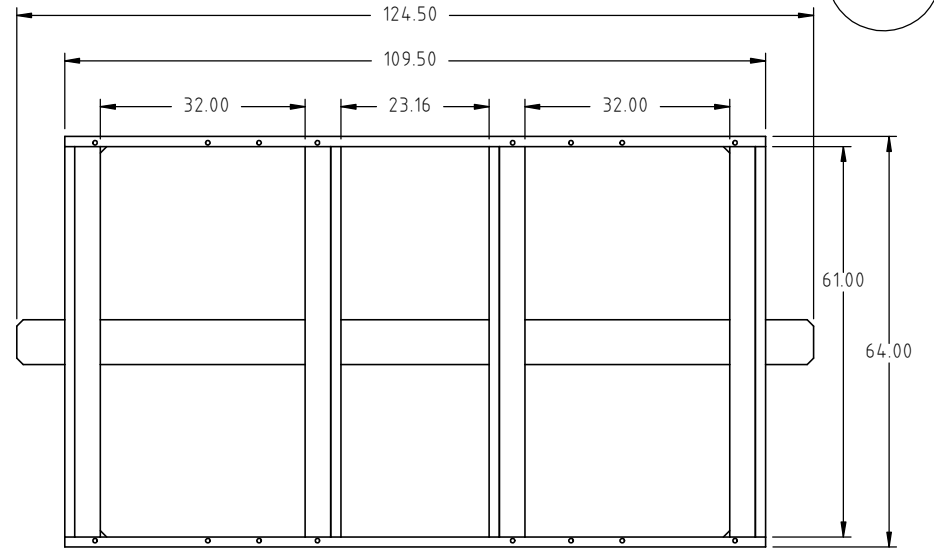

				DRAWN / DATE ADH 3/23/09	MATERIAL
				APPROD. / DATE KGJ 6/23/17	
REV	DESCRIPTION	BY / DATE	CCN		
	ALL DIMENSIONS ARE IN DECIMAL INCHES TOLERANCES UNLESS OTHERWISE SPECIFIED	THIRD ANGLE PROJECTION ANSI 14.5M		SHOT WEIGHT:	NOTES:
	POLYETHYLENE			SHIPPING WEIGHT:	
	±1% @ 68°F			FINISH:	
	METAL DECIMAL ± .125" FRACTION ± 1/4" ANGLE ± 1°				



Den Hartog
INDUSTRIES, INC.

Acra Roto-Mold Injection Molding Blow Molding Sowjoy

4010 HOSPERS DRIVE S. BOX 425, HOSPERS, IOWA 51238-0421

DESCRIPTION	FS, SKID 1800 GALLON WITHOUT SUMP	
SCALE	N.S.	PART NO. FS1800-SKW